

# All Transfer Printers

m4



## M4 - The model for starters

with USB and Ethernet interface as standard

Print resolution	dpi	203	300
Print speed	mm/s	150	100
Print width	mm	104	108.4
Liner width	mm	120	120

a3-2



## A3-2 - The narrow one

for labels up to 60 mm width

Print resolution	dpi	300
Print speed	mm/s	150
Print width	mm	54.2
Liner width	mm	65

a3



## A3 - The universal printer

with printhead up-grade 203 to 300 dpi

Print resolution	dpi	203	300
Print speed	mm/s	200	150
Print width	mm	104	108.4
Liner width	mm	120	120

a4



## A4 - The fast one prints up to 250 mm/s with 300 dpi The precise one prints with 600 dpi

Print resolution	dpi	300	600
Print speed	mm/s	250	100
Print width	mm	105.6	105.6
Liner width	mm	120	120

a6



## A6 - The wide one

for labels up to 176 mm width

Print resolution	dpi	300
Print speed	mm/s	200
Print width	mm	162.6
Liner width	mm	180

a8



## A8 - The extra wide one

for labels up to 220 mm width

Print resolution	dpi	300
Print speed	mm/s	150
Print width	mm	216.8
Liner width	mm	235

# The Printers convincing basic Benefits



## The Solid Housing

It is manufactured from die-cast aluminum. All print mechanics are fixed precisely at the housing. The spindles are mounted in ball bearing washers without wearing for the whole service life.

## Most compact in its class

The two-piece cover conveniently folds while opening. So the printer requires the smallest footprint in its class.

The cover is manufactured of shock resistant plastic like the hard helmets in the building industry.

## Most robust in its class

On request the transfer printers are available with full metal cover (standard with the A8). This cover is retrofit to all printers.

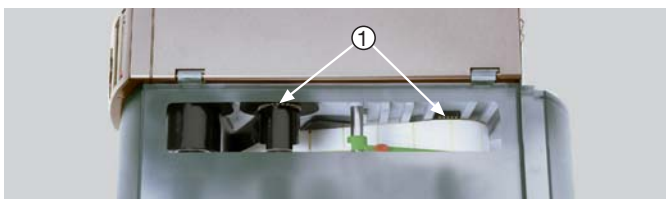

## ▲ Top Media Window in plastic cover

With the top media window you can even monitor narrow label stock and ribbon. Indicators ① on the label and ribbon hubs tell the user when it's nearly time to load more media

## Large Media Window ►

The large media window in the plastic and metal cover is located on the side of the printer to allow easy viewing and monitoring of the remaining label stock and ribbon.





## Easy Handling

### Easy Loading of Labels and Ribbon

The revolving media retainer secures even small label rolls in place. The diameter of the axis can be increased or decreased for easy loading and unloading of ribbon and liner.

### Memory Card

On the CompactFlash memory card you can store label formats, fonts, text and graphics. The card can be loaded in the printer or using a PC.

### Graphic Display

The graphic display monitors the current status of the printer and shows operation hints in 22 languages.

### Convenient Navigator Pad

The Navigator Pad allows clear operation control. The illuminated keys highlight the active functions. With the graphic display the operation is easy to understand.



### The A3: Printing with 203 or 300 dpi in one device

You can change quickly and easily the printhead from 203 to 300 dpi (or reverse) without making adjustments on the printer. At power up, a printhead diagnosis will automatically detect the type of printhead and examine all dots for functionality.

### Automatic Print Positioning

After loading a new roll of labels and pressing the Feed key, the print position will be detected after only dispensing a couple labels. The label position is now held in memory when you turn off the printer. The next time you turn on the printer, he will actually print without wasting the first label.

## Modular Construction



### Plug & Play Peripheral Accessories and Simple Interface Additon

Simply connect the accessory to the peripheral port ① and mount the assembly in front of the print rollers. The interface extension slot can be used to add another interface. The printer automatically senses where the data is coming from and at once the device is ready for the job.

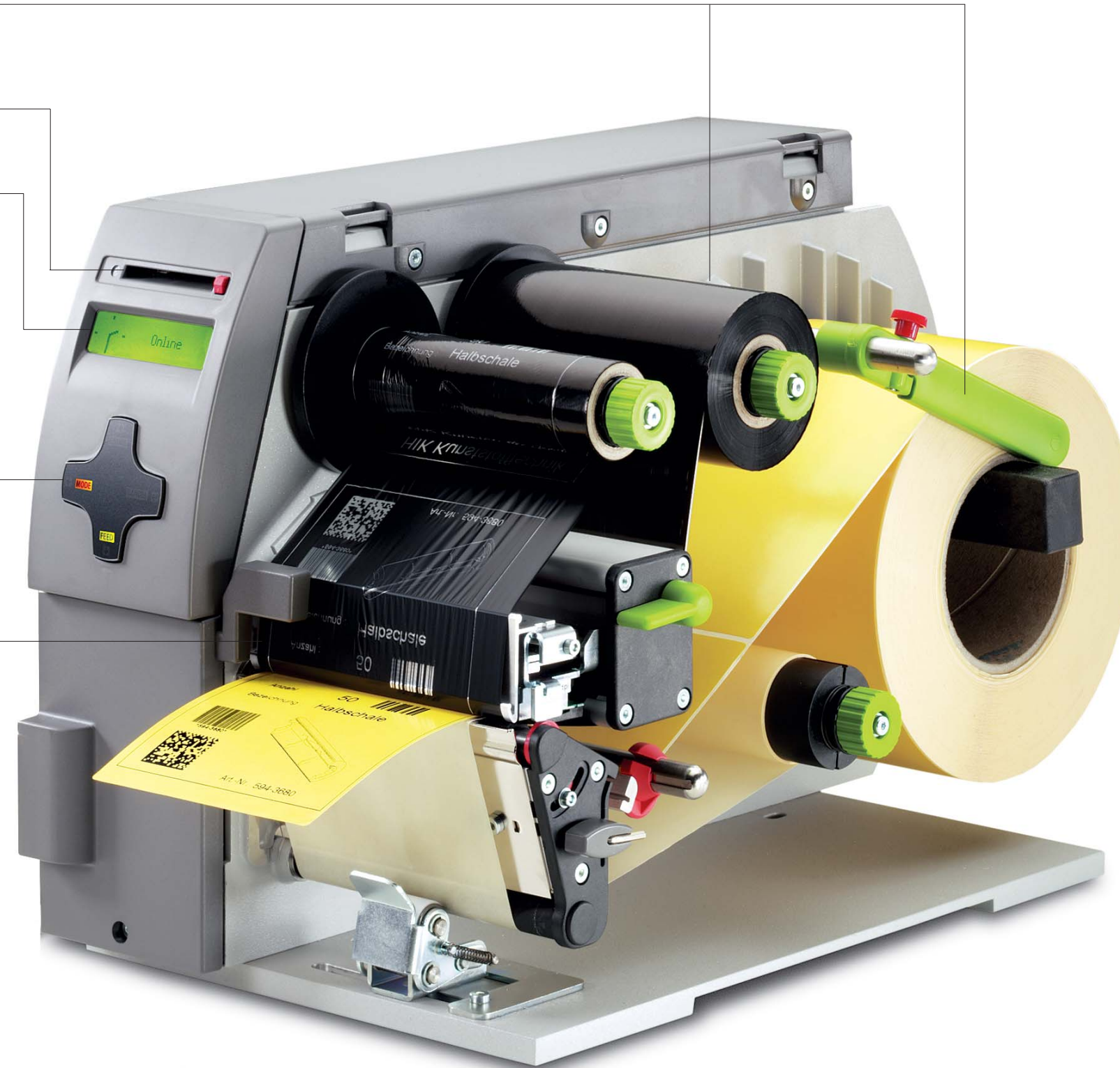

## Maintenance and Service

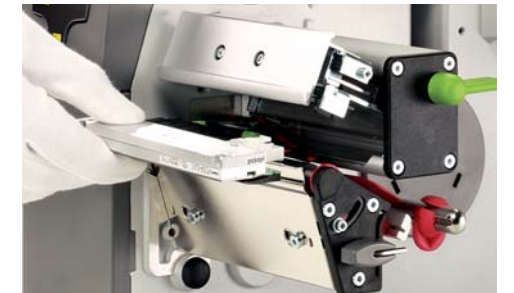

### Printhead

The printhead opens wide for easy cleaning. In this position the printhead can be exchanged easily.



### Label Gap Sensor

The label gap sensor can be removed completely with one touch of a finger and simply pulling it out. The bottom is flat without dirty corners.



### Print Roller

For cleaning or replacement, the print roller can be easily removed simply by loosening three screws.



### One Tool for all Maintenance Tasks

For adjustments, attaching accessories, additional interfaces or spare parts an Allen key is the only tool needed, which is included with every printer.



# The right Accessories for every Application



**P-version with present function**

## Dispensing Labels

On the present plate the label is peeled off from the liner. The imprint and dispense quality is very high due to the additional driven rewind assist roller and the locking system.

There are three present modules to handle the present function:

### PS 8: Present sensor for the A/M-Series manual operation



The present sensor indicates the label in the present position and stops the printing job. After removing of the label, the next one is printed.

### PS 6: Present sensor for the A-Series manual and automatic operation



The indication of the label in the present position is also done via the present sensor. With an additional accessories interface status reports like "label in present position" or "printer offline" can be send to an external application.

### PS 5: Peel-off adapter for the A-Series automatic operation



The peel-off adapter runs without an optical sensor. The transfer of the label by an applicator or roboter is generated by an external signal. All other functions are identical to PS6.

### Present trigger for PS5 and PS6



To start the print and the presenting of the next label a connection of a present trigger or foot switch is possible.



**Basic device**

## Printing and Tearing off Labels

After printing, labels and continuous material can be torn off using the tear-Off plate.

### PS7: Pause adapter for the A-Series



Via the accessories interface the print job can be interrupted and the status of the printer can be requested in all A-Series printers.



**Basic device**

## Cutting Labels

The cutter is used to cut labels, cardboard, textil or plastic foils or even heat-shrinkable tubes one label after the other, after a certain number of labels or at the end of the print job. We recommend that you test very rigid or thin material in advance.

The cutter tray is useful for collecting cut labels that are a width of 30 - 116 mm/1.18 - 4.56" and a height of 12 - 100 mm/0.47 - 3.93". The maximum stacking height is 36 mm/1.41".



**R-Version with internal rewinder**

## Internal Rewinding of Labels

Label rolls up to 145 mm/5.7" diameter

can be rewinded with the internal rewinder after printing.



**Basic device**

## External Rewinding of Labels

Label rolls up to 210 mm/8" diameter

The rewinder is fixed direct to the transfer printer. The winding can be inside or outside by choice.



### External Operation Panel

When using the system in automated production lines it is possible to connect additionally an external operation panel. This may be used as desk top or for integration. With a USB cable it is connected to the USB Master interface of the printer (order separately).

### Direct Keyboard and Scanner Connection for Stand-Alone Mode

With keyboard or scanner the printers can be used without a PC in stand-alone mode.

The PC keyboard will be connected to the USB Master interface of the printer. If keyboard and scanner will be operated at the same time, a hub is needed.

Label formats, fonts, standard texts and graphics are stored on the CompactFlash-memory card.



### Barcode Tester

The built-in scanner tests the barcodes directly after printing. If the barcode is not readable the printing process will be stopped at once so the faulty label can be removed. The barcode tester reads most linear barcodes positioned along the printing direction.

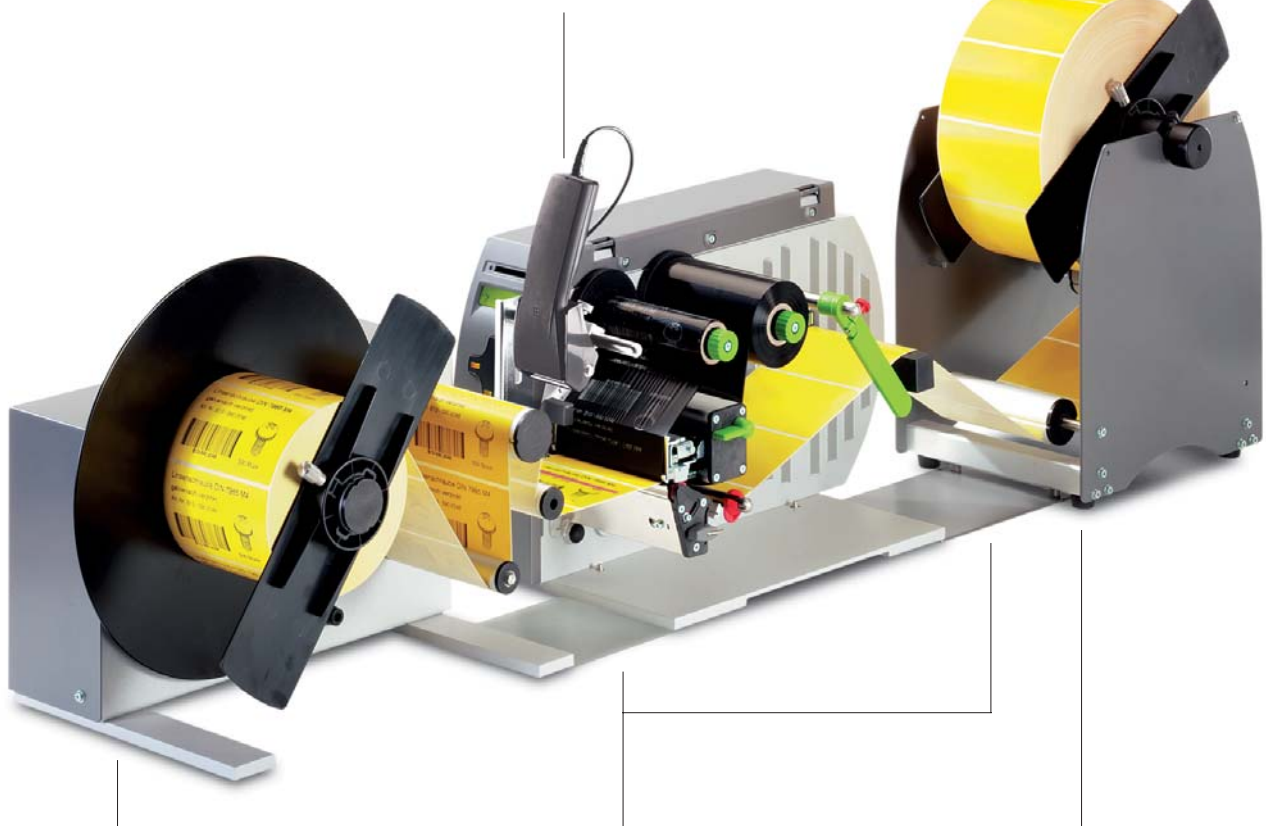

### External Rewinding of Labels

Label rolls up to 300 mm/11.81" diameter

With the built-in power supply the re-winder is operated independent to the printer. The guide is adjustable to the individual label exit height of several models of printers.

### Adapter plate for A/M-Series

With the adapter plate the correct position of the re- and un-winder to the printer ist fixed.

### External Unwinding of Labels

Label rolls up to 300 mm/11.81" diameter

The un-winder works with inside or outside wound label rolls.

# The A 1000 Applicator for Real Time Print and Apply

The applicator A 1000 represents, in combination with the thermal transfer printers A3 and A4, the inexpensive solution both for the semi-automatic labeling and for the integration into automated production lines.

## For Small and Big Labels

Labels with a height of 25 - 150 mm and with a width of 25 - 116 mm may be applied. The printer enables to use label rolls with a diameter of up to 210 mm.

## Quick Assembly

Like any other accessory, the applicator is plugged into the printer with two stoppers and fixed with only one screw.

## Variable Product Heights

By means of the pneumatic cylinder with a stroke of 300 mm it is possible to compensate differences in product heights of up to 150 mm. It is also possible to use cylinders with a longer stroke.

## Simple Adjustment

Four screws are necessary to adjust the tamp pad according to the dispensing edge. The sequence of the whole cycle may be optimized during the test operation at the operator panel.

## High Process Reliability

The supporting air jet streaming and the vacuum as well as the speed of the cylinder are adjustable. For highly sensitive products and packaging the pressure to apply labels may be reduced to less than 1 kg. Consequently there is no risk of injury. To avoid contamination within the vacuum channels these are cleaned by air pressure impulse at the end of each application.



## Long Operating Life without Wearing

The guides have ball bearings which avoid wearing and guarantee more than 2 million cycles

## PLC Interface

For all status and control signals



## Tamp Pad

During this print and apply cycle the product remains in fixed position. The universal tamp is covered by a foil. According to the size of the label the holes may be pierced. On request, the tamp pads are customized to the dimensions of the label sizes.



## Blow Pad

For applying pressure to sensitive products the label may be blown on to the product by the supporting air jet stream. The print and apply cycle performs in a fixed position or in linear movement of the product. The blow pad moves to a pre adjusted position approx. 10 mm away from the product.



## Roll on Pad

Using the roll on pad the label is dispensed until touching the roller. The tamp pad moves on top of the product. The label is then rolled on and applied by the movement of the product.





### Lower Frame

The lower frame may be customized according to the special requirements regarding width and height. The print and apply system is positioned by using two bolts. The exact position of the system may be adjusted on a guide rail.



### Stand A 1600

For great stability the stand is made of aluminum profiles so the print and apply system is ready for use on any automated production line. Also it can easily be adjusted in height and width to fit any product.

The guide rollers allow for smooth movement and transporting while the adjustable mounting pads allow easy positioning for the print and apply system for operation.

The print and apply system is mounted on a base plate that is 10 mm thick and is fixed using only a clamp.



### Present Trigger/Foot Switch

The present trigger or foot switch can be used for semi-automatic applications.



### Light Barrier

A light barrier or sensor can be mounted to automatically recognize a product on a conveyor belt.



### Interface Plug

Easily connected using simple clip screws.

# Interfaces for every Application

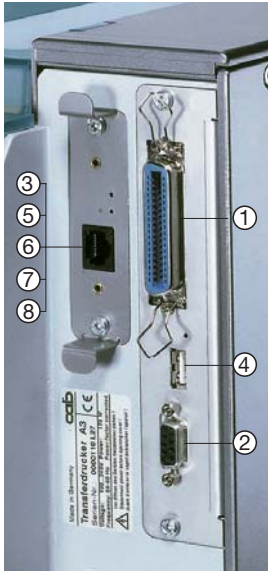

## PC-Connections

1. Bi-directional Centronics interface in acc. with IEEE 1284
2. Serial RS232 C-interface up to 230.400 Baud
3. USB-slave interface

## Stand-Alone-Mode

4. The USB-master interface for connecting PC keyboards or scanners

## Network Connection

5. Ethernet 10/100 Base T interface with TCP/IP protocol  
Printing with LPR/LPD or Raw IP-Printing  
IP address can be set manually or obtained via DHCP  
Status inquiry and settings via internet browser  
FTP for firmware updates, control of CompactFlash card files  
Messages can be sent via email or SNMP  
Time and date can be synchronized with a time server
6. Wireless LAN connection with optional bridge for every operation system

## Industrial Serial Interface

7. Serial RS422 interface for long distance communication
8. Serial RS485 interface for networking up to 26 printers

## Connection to IBM Host Computer

9. Twinax Converter for connection to IBM AS 400
10. Coax-Converter for connection to IBM 3270



# Programming

## Direct Programming

cab printers can easily be controlled using direct programming. The printer language „J-Script“ is easy to understand and the printer can be quickly integrated into a system. In the grey box you see an example from the programming manual.

<p>J H 100 O R S I1;0,0,68,70,100 T 10,10,0,5,pt20;sample B 10,20,0,EAN-13,SC2;401234512345 G 8,3.5,0;R:30,9,0.3,0.3  A 1</p>	<p><b>Job start</b> <b>Speed setting (100mm/sec)</b> <b>Orientation Rotated by 180°</b> <b>Size of the Label (100x68mm, gap 2mm)</b> <b>Text line/font:Swiss bold, 20 pt</b> <b>Barcode EAN 13, size SC 2</b> <b>Graphic, Rectangle 30x9mm,</b> <b>Line thickness 0.3mm</b> <b>Amount of labels (in this sample 1)</b></p>
---	--

## Connection to Host Applications

It is a simple task to link the transfer printer with other host applications with the CompactFlash memory card which allows to store label formats and fixed data. The host computer simply transfers the required variable data to the printer. The example here shows one possible connection to SAP R/3.

<p>Label design with labeling software</p>	<p>Replace file loaded in SAPScript</p>	<p>Exchange of variable data with SAPScript and print out</p>
<p>Upload-Methode SAP R/3 note no. 135 894</p>		

## Scale connection

The connection to scale systems and automates are very easy. With the ABC-programing the printer is very flexible interpreting and using foreign data streams. For this reason the printer is able to control the complete process.





# Software and Tools

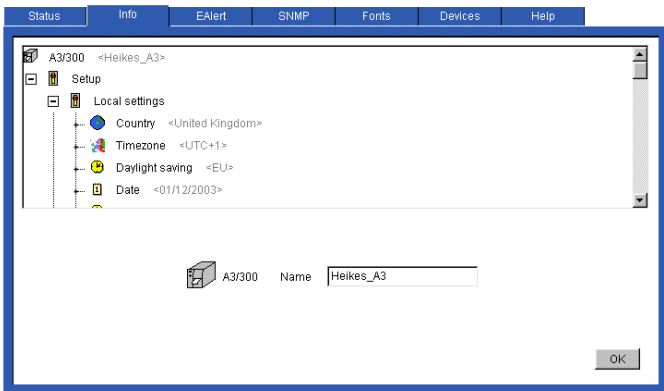

## Configuration through Intra- and Internet

With the built in HTTP and FTP server you can monitor and configure the printer with standard programs like webbrowsers and FTP clients, also updating the firmware and administrate the memory card. Status, warning and error messages can be send by the built in SNMP and SMTP client to administrators and user via email or as a SNMP datagramm.

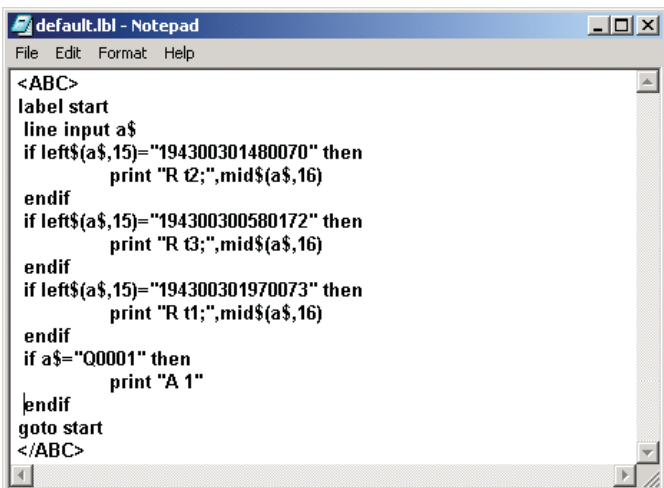

## abc - Basic Compiler

The Basic compiler is an integral part of the printers firmware. It enables the printer, using simple basic programming, to process data, before it has been passed to the pre-printing process. By Using this method printers from other manufactures can be replaced or data streams to other systems such as scales or a PLC be can be integrated and the relevant information printed in various label formats.

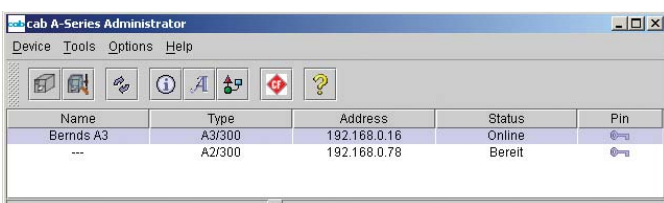

## Administrator Tool

With the cab A-Series administrator tool, many printers can be controlled from one place in a network. The print status, control and administration of the CompactFlash card as well as the updating of the printer firmware and the PIN administration can be done efficiently from only one network-PC.

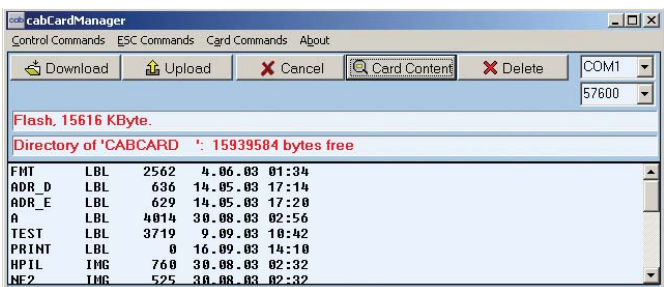

## cab Card Manager

With the Card manager you administrate via the RS232 interface to the memory card. Label formats, true type fonts, graphics and complete data-bases can be quickly and easily downloaded, accessed and modified.

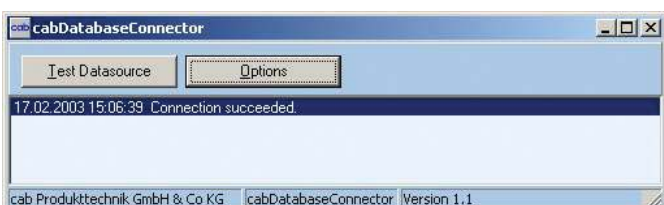

## Database Connector

The Database connector enables all A-Series printer in stand-alone mode to request data via TCP/IP direct from a central SQL-capable data base and print them on the label. While printing data can be send back and altered in the data base using the Database connector.

# Design your Labels quick and easy

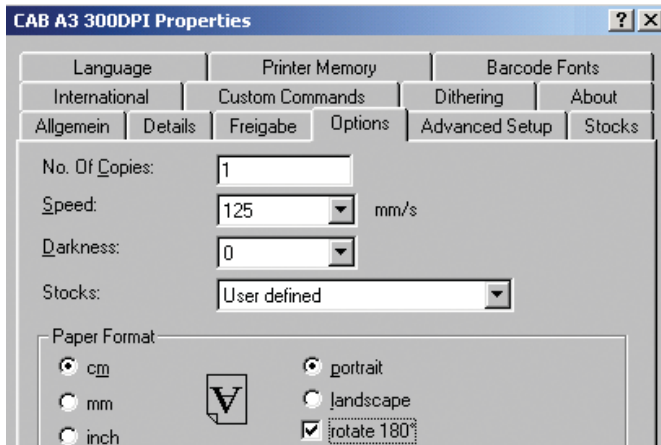

## Free cab Windows Driver - with every Printer

With every shipped printer you get a free Windows Driver. You can create and print your label using a Windows based program such as MS Word, Excel, Access, Works, Corel Draw, and more.

The Windows Driver runs under Windows 95, 98, ME, 2000, XP and NT 4.0.

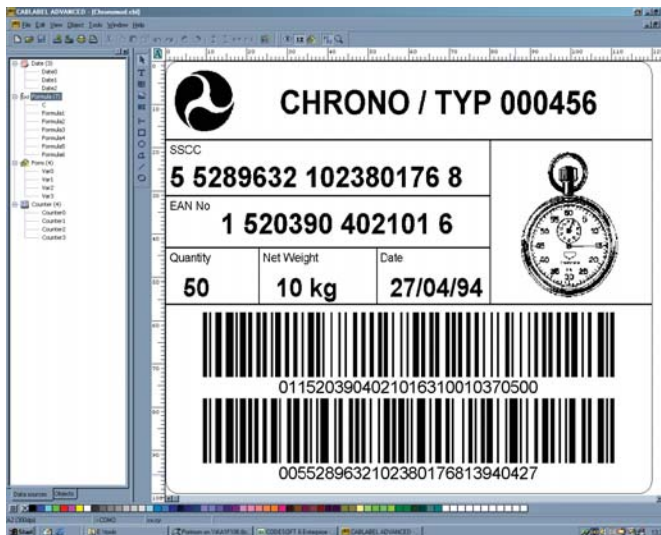

## Labeling Software

cablabel is the cost effective software to create professional labels especially for cab printers. More extensive software packages for your PC such as Easylabel, Codesoft, Nice Label, Bartender and LabelMatrix allow to design label formats to meet highest demands and print them on our printers.



## Quality Got a Look

An optimal arrangement of a label is a free creation of character sizes, fonts and directions. The printer of the A-Series offers a selection of internal bit-map - and vector fonts and you can download additional TrueType fonts. A-Series supports the most popular codepages. For this reason, country specific characters are printable.

## Print all Popular Barcodes

The Printers of the A-Series prints all popular linear or 2D-barcodes clearly and readable.

## Graphics

Several graphic formats (PCX, IMG, BMP, TIF and others) and graphic elements (line, arrow, box, circle, ellipse, filled segments and others) could be integrated in the label.

# Technical Data Transfer Printers and Accessories

	M4		A3-2	A3		A4		A6	A8
Printing method	Thermal direct/Thermal transfer								
Printhead system	Thick film		■	■	■	■	■	■	■
	Thin film		-	-	-	-	-	-	-
Printhead resolution dpi	203	300	300	203	300	300	600	300	300
Print speed up to mm/s	150	100	150	200	150	250	100	200	150
Print width up to mm	104	108.4	54.2	104	108.4	105.6	105.6	162.6	216
<b>Labels</b>									
Material - labels, continuous mat. on rolls or leporello	Thermal and standard paper, cardboard, textil <sup>1</sup> , plastic foil: PE, PP, PVC, PA								
Material thickness mm / Weight g/m <sup>2</sup>	0.07 - 0.25 / 60 - 250 / thicker material on request.								
Media roll									
Total diameter up to mm	210								
Core diameter mm	38.1 - 76								
Winding direction	inside or outside (internal rewind only outside)								
Width of liner mm	120	65	120		180		235		
Label width mm	12 - 116	12 - 60	12 - 116		50 - 176		50 - 220		
Label width when dispensing <sup>2</sup> min. mm	25								
Label height mm	5 - 1000			5 - 250			6 - 1000		10 - 650
Label height when dispensing <sup>2</sup> min. mm	12								
<b>Ribbon</b>									
Ink	ink inside or ink outside								
Roll diameter up to mm	80								
Core diameter mm	25								
Running length variable up to m	500								
Width up to mm	114	56	114		165		220		
<b>Internal rewinder</b>									
Total diameter up to mm	145								
Core diameter mm	38,1								
Winding direction	only outside								
<b>Dimensions</b>									
Height /Depth mm	274/446								
Width mm	242	190	242		302		352		
Weight kg	9	8,5	9		13		15		
Energy consumption max. W	200	250		500					
<b>Label sensor</b>									
See-through/ Reflective sensor from below, Adjustable mm	4 - 57.5								
<b>Electronics</b>									
Processor 32 Bit ColdFire	64 MHz				144 MHz				
RAM	8 MB				16 MB				
ROM	4 MB Flash		2 MB Flash			4 MB Flash			
Slot for memory card: CompactFlash Type I	■		■						
Real time clock/date	■		■						
Operation panel as Navigatorpad: keys/backlights	3/4		4/8						
LCD-graphic display: text 2 lines/20 characters, symbols	-		■						
<b>Interfaces</b>									
Serial RS 232 C 1,200 bis 230,400 bauds/8 bit	■		■						
RS 422, RS 485 1,200 bis 230,400 bauds/8 bit	-		□						
Parallel Centronics bidirectional acc. IEEE 1284	-		■						
Ethernet 10/100 Base T, LDP, RawIP-Printing, DHCP, HTTP, FTP, SMTP, SNMP, Time	■		□						
Wireless LAN - on request	□		□						
USB Slave for PC connection	■		□						
Twinax/Coax Converter for IBM connection	-		□						
USB Master for keyboard and scanner	-		■						
Peripheral connection	■		■						
<b>Accessories</b>									
Cutter, Present sensor manual operation	□		□						
Present sensor automatic operation, Pause adapter, External operation panel, Barcode tester	-		□						
Applicator	-		□			-		-	
External rewinder	□		-						
External unwinder	□		-						
PC-keyboard USB	-		□						
<b>Memory card</b>									
CompactFlash Type I 16 up to 512 MB	□		□						
<b>Power supply</b>									
Power supply	100 - 240 V - 50/60 Hz, PFC								
Operating temperature/humidity not condensing	10 - 35 °C/30 - 85%								
Safety regulations	CE, FCC class 1								

<sup>1</sup> depending on material limitations

<sup>2</sup> Depending on label size, material and adhesive limitations are possible.

We therefore recommend to test the dispense ability and print tolerances in advance.



	M4 / A3-2 / A3 / A4 / A6 / A8
Font types	5 Bitmap-Fonts incl. OCR-A, OCR-B and 3 vektor fonts Swiss 721, Swiss 721 Bold and Monospace 821 available internally, loadable TrueType fonts
Character sets	Windows 1250 up to 1257, DOS 437, 737, 775, 850, 852, 857, 862, 864, 866, 869, EBCDIC 500, ISO 8859-1 up to -10, -13 up to -16, WinOEM 720, UTF8, Macintosh Roman, DEC MCS, KOI8-R. All West and East European latin, cyrillic, greek, hebrew and arabic characters are supported.
<b>Font sizes</b>	
Bitmap fonts	Size of width and height 1 - 3 mm scalable factor 2 - 10
Vektor fonts	Size of width and height 0.9 - 128 mm infinitely scalable
Font formats	Bold, italic, underlined, outline, negative, grey, vertical, depending on character fonts
Font width	Extended, compressed
<b>Print directions</b>	
Bitmap fonts/barcodes	0°, 90°, 180°, 270°
TrueType fonts	360° of rotations in 1°, mirrored label image
<b>Graphics</b>	
Graphic elements	Line, arrow, box, circle, ellipse, filled, filled with fading
Graphic formats	PCX, IMG, BMP, TIF, MAC
<b>Barcodes</b>	
Linear Barcodes	Code 39, Code 93 Interleaved 2/5 Code 128 A, B, C Ident and lead code Codabar of Deutschen Post AG EAN 8, 13, 128 Jan 8, 13 EAN/UCC 128 MSI EAN/UPC Appendix 2 Plessey EAN/UPC Appendix 5 Postnet FIM RSS 14 HIBC UPC A, E
2D-Barcodes	Aztec, Codablock F, Data Matrix, PDF 417, Micro PDF, UPS Maxicode, QR-Code All barcodes variable in height, module width and ratio. Optionally with check digit, printed characters and start/stop code depending on barcode type.
<b>System checks</b>	
Printing if	Ribbon available Labels /continuous material available Printhead closed (only A-Series)
Test facilities	System diagnosis of memory when powerd ON System diagnosis of printhead when powerd ON (only A-Series), Print-out of system data
Status reports	Total print length Total operation hours
<b>Software</b>	
Windows driver	95, 98, ME, 2000, XP Windows NT starting with version 4.0
cablabel	As Lite free version in the content of delivery. With the Advanced, Professional and Expert versions you create even complex labels.
Tools	Administrator tool for printers with Ethernet card to administrate several printers
abc-Compiler	Basic compiler to run individual programs

## Cutter

	M4	A3-2	A3/A4	A6	A8
Material weight up to g/m <sup>2</sup>	500				
Material width up to mm	120	65	120	180	232
Material height from mm	2 - depending on material limitations				

## External Rewinder

	M4	A3-2/A3/A4	A6	A8
Total diameter mm	ER 1, 2, 3 210			
	ER 4 300			
Core diameter mm	40 (with or without cardboard core) 76 (with cardboard core)			
Material width up to mm	120		180	235
Winding speed up to mm/s	300		250	200
Winding direction	inside or outside			
Power supply	ER 1, 2, 3 ER 4, 6, 8 from transfer printer with internal power supply			

## External Unwinder EU 4, 6 and 8

Total diameter mm	300		
Core diameter mm	40 (with or without cardboard core) 76 (with cardboard core)		
Material width up to mm	120	180	235
Winding direction	inside or outside		

## PC-Keyboard USB

No. of keys	-	104 or 105 dep. on country
Dim. (length x width) mm	-	470 x 195
Interface at transfer printer	-	USB
for additional accessories	-	4 port buspowered Hub
Manufacturer / Type	-	Cherry / Classic Line G81 3000

## Compact PC Keyboard USB

No. of keys	-	86
Dim. (length x width) mm	-	282 x 132
Interface at transfer printer	-	USB
Manufacturer / Type	-	Cherry / Slim Line G84 4100

## Applicator f. A3-2/A3/A4

	Typ A 1000		
Label transfer method	Tamp	Roll on	Blow
Label width in mm	25 - 116	25 - 116	25 - 100
Label height in mm	25 - 150	80 - 150	25 - 100
Cylinder stroke in mm	220/300		
Stoke of tamp below printer mm	70/150		
Compressed air supply in bar	> 5		
Requirements to product surface	flat		
<b>Product height</b>			
variable	■	■	-
fixed	-	-	■
<b>Product</b>			
fixed	■	-	■
linear movement	-	■	■
<b>Labeling direction</b>			
vertically downwards	■		

## Stand for A3-2/A3/A4



	A 1600
Height total mm	1600
Height of product up to mm	1500
Overhang til middle of label mm	230 - 500
Chassis frame (distance adjust feet)	
Width mm	600
Depth mm	860
Height mm	140

# Delivery Program Transfer Printer





	Basic device	R-version	P-version (without present sensor)
tear off	■	□	□
internal rewind	-	■	□
dispense	-	-	■
cut	□	□	□
external rewind	□	□	□

Standard  
 Accessories

	Printhead	Part No.	Description	Part No.	Description	Part No.	Description
<b>M4</b> 	203 dpi	<b>5946730</b>	Thermal-direct Printer M4/200	<b>5946731</b>	Thermal-direct PrinterM4/200R	<b>5947962</b>	Thermal-direct Printer M4/200P
	203 dpi	<b>5946720</b>	Transfer Printer M4/200	<b>5946721</b>	Transfer Printer M4/200R	<b>5947960</b>	Transfer Printer M4/200P
	300 dpi	<b>5946733</b>	Thermal-direct Printer M4/300	<b>5946734</b>	Thermal-direct Printer M4/300R	<b>5947963</b>	Thermal-direct Printer M4/300P
	300 dpi	<b>5946723</b>	Transfer Printer M4/300	<b>5946724</b>	Transfer Printer M4/300R	<b>5947961</b>	Transfer Printer M4/300P
<b>A3-2</b> 	300 dpi	<b>5948720</b>	Thermal-direct Printer A3-2/300	<b>5948721</b>	Thermal-direct Printer A3-2/300R	<b>5948722</b>	Thermal-direct Printer A3-2/300P
	300 dpi	<b>5948700</b>	Transfer Printer A3-2/300	<b>5948701</b>	Transfer Printer A3-2/300R	<b>5948702</b>	Transfer Printer A3-2/300P
<b>A3</b> 	203 dpi	<b>5946700</b>	Thermal-direct PrinterA3/200	<b>5946701</b>	Thermal-direct PrinterA3/200R	<b>5947957</b>	Thermal-direct Printer A3/200P
	203 dpi	<b>5942300</b>	Transfer Printer A3/200	<b>5942315</b>	Transfer Printer A3/200R	<b>5947950</b>	Transfer Printer A3/200P
	300 dpi	<b>5946703</b>	Thermal-direct Printer A3/300	<b>5946704</b>	Thermal-direct Printer A3/300R	<b>5947958</b>	Thermal-direct Printer A3/300P
	300 dpi	<b>5942301</b>	Transfer Printer A3/300	<b>5942316</b>	Transfer Printer A3/300R	<b>5947951</b>	Transfer Printer A3/300P
<b>A4</b> 	300 dpi	<b>5946004</b>	Transfer Printer A4/300	<b>5946009</b>	Transfer Printer A4/300R	<b>5947952</b>	Transfer Printer A4/300P
	600 dpi	<b>5946005</b>	Transfer Printer A4/600	<b>5946010</b>	Transfer Printer A4/600R	<b>5947953</b>	Transfer Printer A4/600P
<b>A6</b> 	300 dpi	<b>5946706</b>	Thermal-direct Printer A6/300			<b>5947959</b>	Thermal-direct Printer A6/300P
	300 dpi	<b>5943203</b>	Transfer Printer A6/300			<b>5947954</b>	Transfer Printer A6/300P
<b>A8</b> 	300 dpi	<b>5946709</b>	Thermal-direct Printer A8/300				
	300 dpi	<b>5945800</b>	Transfer Printer A8/300				

### Examples

	Part No.	Description
 The printers M4, A3, A4, A6 and A8 are available with metal cover. Add to the part no. the coding .101	<b>5942300.101</b>	Transfer Printer A3/200 metal cover
The A3 and A4 could be supplied with a factory installed RFID Read-Write Unit with Ethernet for the marking of smart labels. Add to the part no. the coding .102	<b>5942300.102</b>	Transfer Printer A3/200 RFID 13.56 MHz/Ethernet
 Do you want the A3 or A4 with metal cover and RFID Read-Write Unit with Ethernet add to the part no. the coding .103	<b>5942300.103</b>	Transfer Printer A3/200 metal cover/RFID 13.56 MHz/Ethernet

**Contents of delivery:** Transfer Printer, Power Supply, Operation manual, Windows driver, cablabel Lite, Service manual on CD-ROM

## Accessories Transfer printer







Part No.	Description	for printer
 5948382	Cutter CU2	A3-2
 5948000	Cutter CU4	M4 / A3 / A4
 5948001	Cutter CU6	A6
 5948002	Cutter CU8	A8
 5946995	Cutter tray 4	M4 / A3 / A4
 5942353	Present sensor PS6 manual/autom. operation	A3-2/A3 / A4 / A6 for P-version
 5946900	Present sensor PS8 manual operation	M4/A3-2/A3/A4/A6 for P-version
 5946120	Peel-off adapter PS5 automatic operation	A3-2/A3/A4/A6 for P-version
 5946146	Pause adapter PS7	A3-2/A3/A4 A6/A8
 5948102	External rewriter ER1 Roll diameter 210 mm	M4/A3-2/A3/A4
 5943251	External rewriter ER2 Roll diameter 210 mm	A6
 5945802	External rewriter ER3 Roll diameter 210 mm	A8
 5948100	External rewriter ER4 Roll diameter 210 mm	M4/A3-2/A3/A4 OM*
 5946090	External rewriter ER4 Roll diameter 300 mm	M4/A3-2/A3/A4 OM*
 5946420	External rewriter ER6 Roll diameter 300 mm	A6 OM*
 5945804	External rewriter ER8 Roll diameter 300 mm	A8 OM*
 5948170	Adapter plate for ER/EU 4, 6, 8	M4/A3-2/A3/A4 A6/A8
OM* = also for printers of other manufactures		
 5946091	External unwinder EU4 Roll diameter 300 mm	M4/A3-2/A3/A4 OM*
 5946421	External unwinder EU6 Roll diameter 300 mm	A6 OM*
 5945806	External unwinder EU8 Roll diameter 300 mm	A8 OM*
OM* = also for printers of other manufactures		
 5948650	Tear-off plate TP2	A3-2 for R/P-version
 5946244	Tear-off plate TP4	M4 / A3 / A4 for R/P-version
 5946414	Tear-off plate TP6	A6 for P-version
 5948651	Rewind guide RG2	A3-2 for P-version
 5946467	Rewind guide RG4	M4 / A3 / A4 for P-version
5948983.001	Metal cover M4	M4
5948984.001	Metal cover A3	A3
5948985.001	Metal cover A4	A4
5948986.001	Metal cover A6	A6
5948987.001	Metal cover A8	A8

without picture

## Accessories Applicator

Part No.	Description	for printer
 5949002	Tamp applicator A 1000-300	A3-2 / A3 / A4
 5949072	Universal tamp pad A1021 70x60	Applicator A 1000
 5949075	Universal tamp pad A1021 90x90	Applicator A 1000
 594xxxx	Tamp pad A1021 wxh	Applicator A 1000
 5949076	Universal tamp pad A1321 116x102	Applicator A 1000
 5949077	Universal tamp pad A1321 116x152	Applicator A 1000
 594xxxx	Tamp pad A1321 wxh	Applicator A 1000
 594xxxx	Blow pad A2021 wxh	Applicator A 1000
 594xxxx	Roll on pad A1411 wxh	Applicator A 1000
 5949093	Lower frame 340x160	A3-2 / A3 / A4
 594xxxx	Lower frame bxh	A3-2 / A3 / A4
 8913600	Stand A 1600	A3-2 / A3 / A4

## Operation panels

Part No.	Description	for device
 5946930	External operation panel	A3-2 / A3 / A4 A6 / A8
 5946930	PC-keyboard USB with 4 Hub/Cherry Classic Line G81 3000	A3-2 / A3 / A4 A6 / A8
 5946930	Compact PC-keyboard USB / Cherry Slim Line G84 4100	A3-2 / A3 / A4 A6 / A8
 5942345	Present trigger TR1	Peel-off Ad. PS5 Present Sen. PS6 Applicator A 1000
 5535901	Foot switch PLC	Peel-off Ad. PS5 Present Sen. PS6 Applicator A 1000
 5941526	Light barrier to start process PLC	Peel-off Ad. PS5 Present Sen. PS6 Applicator A 1000



# Delivery Program Transfer Printer

## Memory cards



Part No.	Description	for printer
5561028	CompactFlash type I memory card 32 MB	M4/A3-2/A3/A4 A6/A8
5561029	CompactFlash type I memory card 64 MB	M4/A3-2/A3/A4 A6/A8

## Interfaces



Part No.	Description	for printer
5942361	USB interface with connect. cable 1.8 m	A3-2/A3/A4 A6/A8
5942360	RS422/485 interface	A3-2/A3/A4 A6/A8
5942363	Fast-Ethernet interface	A3-2/A3/A4 A6/A8
5561034	Wireless bridge with connecting cable and power supply	M4/A3-2/A3/A4 A6/A8
5551279	Twinax converter for IBM AS 400	A3-2/A3/A4 A6/A8
5551280	Coax converter for IBM 3270	A3-2/A3/A4 A6/A8

## Software



Part No.	Description	for use with
5580153	cablabel 6 X-Lite	98/ME/2000/XP/NT
5580150	cablabel 6 Advanced	98/ME/2000/XP/NT
5580151	cablabel 6 Professional	98/ME/2000/XP/NT
5580152	cablabel 6 Expert	98/ME/2000/XP/NT
5580154	cablabel 6 run Time	98/ME/2000/XP/NT
5580215	Admin Tool	98/ME/2000/XP/NT
5580216	cab Card Manager	98/ME/2000/XP/NT
5580210	Database Connector	98/ME/2000/XP/NT

## Connecting cables



Part No.	Description	for printer
5550818	Cable RS232 C, 9/9-pin, length 3 m	M4/A3-2/A3/A4/ A6/A8
5550771	Cable parallel Centronics, length 1.8 m	A3-2/A3/A4 A6/A8
5901616	Cable USB, Length 1.8 m	M4/A3-2//A3/A4 A6/A8
5917651	SUB-D-plug 25-pin for SPS Phönix Contact No. 27 61 62 2	Applicator A 1000
5917652	SUB-D-plug 15-pin for SPS Phönix Contact No. 27 61 60 6	Peel-off Ad. PS5 Present Sen. PS6 Applicator A 1000

## Spare parts



Part No.	Description	for printer
5948640	Printhead 300 dpi type 2300	A3-2
5942370	Printhead 203 dpi type 4203	M4 / A3
5942371	Printhead 300 dpi type 4300	M4 / A3
5946015	Printhead 300 dpi type 4300S	A4
5946006	Printhead 600 dpi type 4600	A4
5943245	Printhead 300 dpi type 6300	A6
5945805	Printhead 300 dpi type 8300	A8
5948617	Driver roller DR2	A3-2
5942372	Driver roller DR4	M4 / A3 / A4
5943210	Driver roller DR6	A6
5945822	Driver roller DR8	A8
5948631	Rewind assist roller RR2	A3-2
5946235	Rewind assist roller RR4	M4 / A3 / A4
5946412	Rewind assist roller RR6	A6

Pictures in this brochure mainly show the A3 printer. However, the most functions are similar to all other A-Series printers. The M4 has different features. Please pay attention to this.

All specifications about delivery, design and technical data are given to the best of our current knowledge and are subject to change without prior notice.



All specifications about delivery, design and technical data are given to the best of our current knowledge and are subject to change without prior notice.

#### Headquarter

##### **Germany**

cab-Produkttechnik GmbH & Co KG

Postfach 1904 D-76007 Karlsruhe  
Wilhelm-Schickard-Str. 14 D-76131 Karlsruhe  
Germany

Phone +49 721 6626-0  
Fax +49 721 6626-249

www.cabgmbh.com  
info@cabgmbh.com

#### cab subsidiaries in other countries

**France:** cab technologies s.à.r.l.  
F-67350 Niedermodern  
Téléphone +33 388 722 501  
info@cab-technologies.fr

**España:** cab España S.L.  
E-08304 Mataró (Barcelona)  
Teléfono +34 937 414 605  
info@cabsl.com

**USA:** cab Technology Inc.  
Tyngsboro MA, 01879  
Phone +1 978 649 0293  
info@cabtechn.com

**Russia:** OOO cab Technology  
RUS-123001 Moscow  
Phone +7 095 937 38 79  
cabrus@co.ru

**South Africa:** cab Technology (Pty.) Ltd.  
2125 Randburg  
Phone +27 11-886-3580  
info@cabtech.co.za

**Asia:** cab Technology Co., Ltd.  
Taipei, Taiwan, R.O.C.  
Phone +886 2 2950 9185  
cabasia@cabgmbh.com

Representatives in other countries on request.