

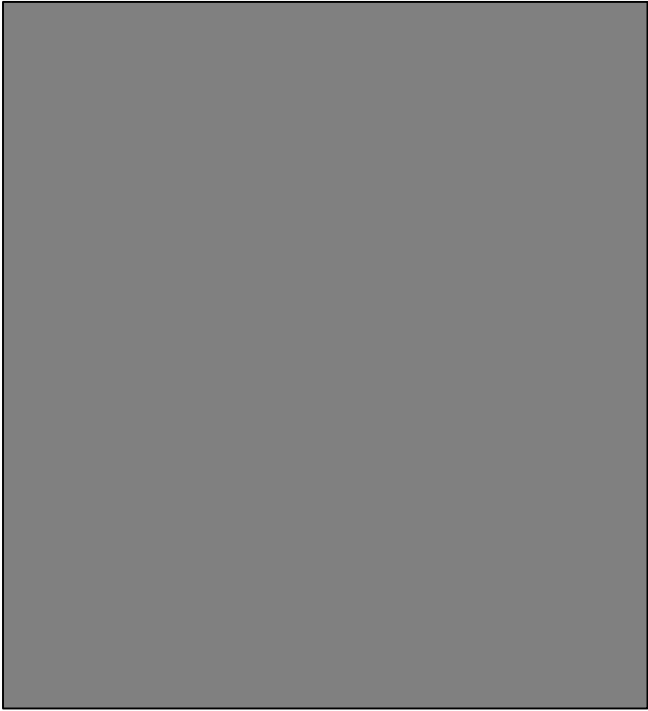

METROLOGIC INSTRUMENTS, INC.

**MS6130 Hand Held Laser Scanner
and MX003 Scanner Interfaces
Installation and User's Guide**





LOCATIONS

North America Headquarters

Metrologic Instruments, Inc. 90 Coles Road Blackwood, NJ 08012-4683	Customer Service: 1-800-ID-METRO Tel: 856-228-8100 Email: info@metrologic.com Website: www.metrologic.com
---	--

Germany

Metrologic Instruments GmbH Dornierstrasse 2 82178 Puchheim b. Munich, Germany	Tel: 49-89-89019-0 Fax: 49-89-89019-200 Email: info@europe.metrologic.com
---	---

South America

Metrologic South America Rua Flórida 1821 - 5º Andar São Paulo, SP, Brasil CEP: 04571-090	Tel: 5511-5505-6568 Fax: 5511-5505-1681 Email: info@sa.metrologic.com
--	---

Brazil

Metrologic do Brasil Ltda Rua Flórida 1821 - 5º Andar São Paulo, SP, Brasil CEP: 04571-090	Tel: 5511-5505-2396 Fax: 5511-5507-2301 Email: info@br.metrologic.com
---	---

Asia

Metrologic Asia (Pte) Ltd 31, Kaki Bukit Road 3 #05-08 Techlink Singapore 417818	Tel: 65-842-7155 Fax: 65-842-7166 Email: info@sg.metrologic.com
---	---

Copyright

© 2000 by Metrologic Instruments, Inc. All rights reserved. No part of this work may be reproduced, transmitted, or stored in any form or by any means without prior written consent, except by reviewer, who may quote brief passages in a review, or provided for in the Copyright Act of 1976.

Products and brand names mentioned in this document are trademarks of their respective companies.

MLPN 2212
Printed in USA
February 2000

TABLE OF CONTENTS

MS6130 Hand Held Bar Code Scanner.....	1
MX003 Series Scanner Interfaces.....	2
Unpacking List	3
Connections of the “MX” Interface to the Host Device.....	4
Connections of the Keyboard Wedge “MX” Interface to the PC	5
Connections of the MS700i/MS720i with “MX” to the Host Device	6
Configuration of the MS700i/MS720i with “MX”.....	7
Configuration of the MS700i/MS720i with “MX” to the Host System.....	8
Configuration of the “MX” to the ScanPal® Data Collector	9
Configuration of the “MX” to the RS-232 Light Pen or Keyboard Wedge Host System	10
Keyboard Wedge (KB) Interface	11
Configuration of the MS6130 Hand-Held.....	15
Enabling the MS700i/MS720i Scanner’s RF Low Speed Option	16
Changing the ID.....	17
Matching Procedure	18
Parts of the MS6130 Hand-Held Bar Code Scanner	19
Components of the MS6130 Series Stand.....	20
Installation of the MS6130 Series Stand.....	21
Installation of the 6000 Series Universal Charging Stand.....	22
NiCd Battery Charger with Reconditioning Feature.....	23
Visual Indicators.....	24
Audible Indicators.....	25
Labels.....	27

TABLE OF CONTENTS (CONTINUED)

Maintenance	27
Troubleshooting	28
Appendix A	
Specifications	29
Appendix B	
Default Settings of the MS6130 and “MX” Interface	32
Appendix C	
MX003 Series Scanner Interface Pin Assignments.....	36
Appendix D	
Warranty and Disclaimer	37
Appendix E	
Notices	38
Appendix F	
Patents.....	39
Index	40

Printer Note:

Leave page blank.

THE MS6130 HAND HELD BAR CODE SCANNER

MS6130 Hand Held Bar Code Scanners are wireless scanners with a mobility range of up to 30 feet from the receiver. When not in use, the scanner rests in a universal-charging stand. The scanner will be fully charged in 2 hours when not scanning in the stand. A fully charged MS6130 can provide up to 8 hours of wireless, hand-held scanning. After dormant periods, the scanner is programmed to enter a timeout mode that will extend the battery life. There is a reactivation switch conveniently located on the side of the scanner to turn the unit back on. The scanner has a replaceable battery pack for added reliability and convenience for your scanning application.

Metrologic's scanner uses wireless data communication to transfer information to the host. The MS6130 may be used with Metrologic's MX003 Series Scanner Interfaces to provide the short range, one-way communication link between the scanner and an RS-232, Keyboard Wedge or Light Pen host device.

The MS6130 uses Metrologic's patented Infrared Object Sensor for triggerless operation. The scanner, after a specified time, will enter a standby mode where the VLD and motor will shut off. Simply present an object in front of the scanner window, the Infrared Sensor will reactivate the scanner and the unit will be ready to scan.

To indicate the status of the scanner, the MS6130 uses a green and red LED located on the top of the scanner. By understanding the flashes of the LED, you can determine a successful read, laser status, low battery power, sleep mode, and program mode. There are audible indicators on the scanner as well. The scanner will beep; one, two or three times to indicate successful power up or scan, low battery, or program mode, respectively, or give a razzberry tone; which indicates the scanner has failed diagnostics upon power up.

In this manual, the MS6130 may be referred to as the scanner or transmitter.

MX003 SERIES SCANNER INTERFACES

Metrologic's MX003 Series Scanner Interfaces provide a short range, one-way wireless data communication link between a remote portable scanner and an RS-232 or light pen host device. Specifically, Metrologic's MS6130 Hand-Held Laser Scanners include a Liberty® RF transmitter board. Metrologic's MS700i/MS720i series scanners, TECH series scanners may be connected to a MX Series scanner interface. The "MX" scanner interface includes a RF receiver and a digital interface board.

The MS6130 scanner provides two functions:

- Scans and decodes bar codes
- Transmits scanned data to the RF receiver or "MX"

When the "MX" interface is connected to a ScanPal® or host device such as a portable data terminal (PDT), it provides two functions (For example, refer to Figure 1):

- Performs the RF receiver function; for example, beeps to show it has received data from the transmitter
- Communicates with the host device

In this manual, MX003 series scanner interfaces may be referred to as the "MX", "MX" interface or receiver. Suffix of the MX003 model designation will vary due to country of usage.

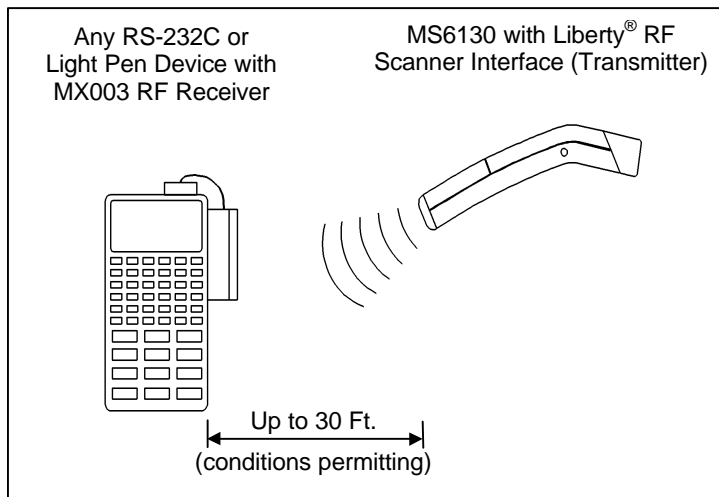

Figure 1

UNPACKING LIST

Your shipment will contain a set of items from the two groups listed below:

Transmitter Group:

- MS6130 Hand-Held Scanner
- Stand #45880 (optional)
- Stand #45558, 45559 and 45560 (optional)
- MS4120 Programming Guide

Receiver Group:

- “MX” Scanner Interface
- MCA951 adapter or adapter cable (if required)
- Regulated 5V power supply, MLPN: 6090/6091 (115/220 V_{AC})(optional)

OR

- “MX” Scanner Interface
- MS700i with Liberty[®] RF Receiver option cable
- Power supply (optional)
- Communication cable with connection for power supply (optional) or communication cable only
- Stand #45483 (optional)
- MS700i and MS720i Installation and User’s Guide
- ScanSelect[™] Scanner Programming Guide (#2186)

OR

- ScanPal[®] Data Collector
- “MX” Scanner Interface
- Upload cable, MLPN: 51061 and 51236
- MCA951 adapter
- Regulated 5V power supply, MLPN: 6090/6091 (115/220 V_{AC})
- ScanPal Data Collector Installation and User’s Guide

CONNECTIONS OF THE “MX” INTERFACE TO THE HOST DEVICE

Except version 17

1. Turn off the host system.
2. Connect the MCA to the host device. Connect the “MX” interface to the MCA.
3. Check the AC input requirements of the transformer to make sure the voltage matches the AC outlet. The socket outlet should be near the equipment and easily accessible.
4. Plug the transformer into the side of the MCA and the AC outlet.
5. Power up the host system.

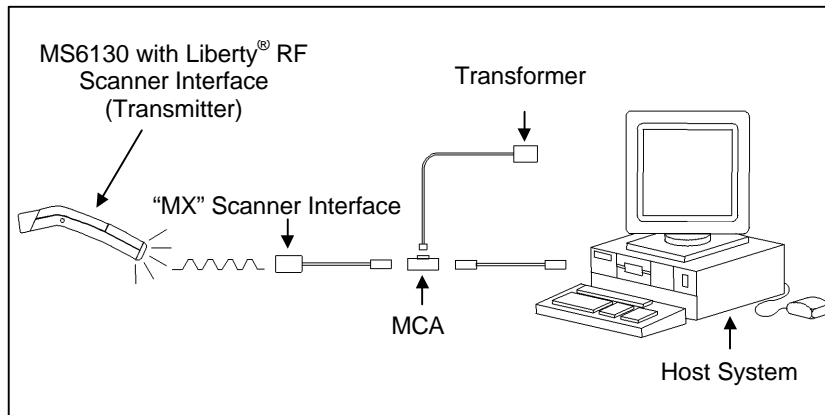

Figure 2: Connecting the “MX” (through the MCA) to a host device



To maintain compliance with applicable standards, all circuits connected to the unit must meet the requirements for SELV (Safety Extra Low Voltage) according to EN 60950.

CONNECTIONS OF THE KEYBOARD WEDGE "MX" INTERFACE TO THE PC

Version 17 only

MX003 Scanner Interfaces with a suffix of "17" are Keyboard Wedge versions used to interface with a PC and keyboard.

1. Turn off the PC.
2. Plug the "MX" receiver adapter cable to the PC keyboard port.
3. Plug the keyboard into the "MX" receiver adapter cable.
4. Power up the PC.

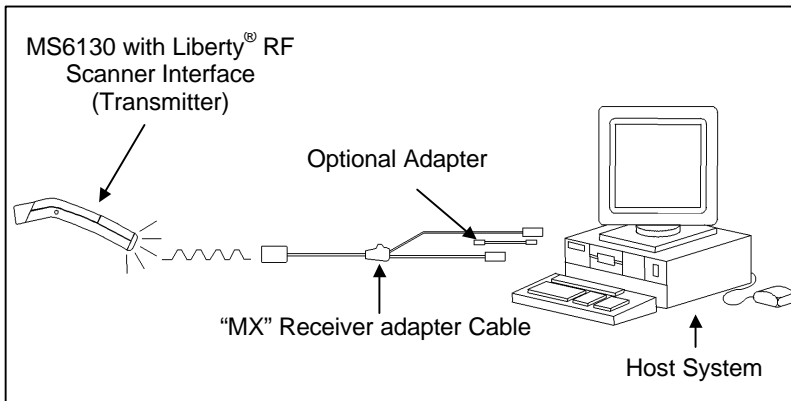

Figure 3: Connecting the "MX" to a PC and keyboard



To maintain compliance with applicable standards, all circuits connected to the unit must meet the requirements for SELV (Safety Extra Low Voltage) according to EN 60950.

The following statement is applicable if the scanner will receive power from a host device such as a computer system.

Caution: To maintain compliance with standards CSA C22.2 No. 950/UL 1950 and norm EN60950, the power source must meet applicable performance requirements for a limited power source.

CONNECTIONS OF THE MS700i/MS720i WITH "MX" TO THE HOST DEVICE



To avoid potential problems, **do not power up the scanner until the communication cable is secured to the host.**

1. Turn off the host system.
2. Connect the 25-pin D-type connector on the MS700i/MS720i scanner's head cable to the communication cable. Connect the other end of the communication cable to the host device. If the scanner will not receive power from a transformer, skip to Step 5.
3. If the scanner will receive power from an external power source, check the AC input requirements of the transformer to make sure the voltage matches the AC outlet. The socket-outlet should be near the equipment and easily accessible.
4. Plug the transformer into the side of the female D-type connector located on the communication cable. Plug the transformer into the AC outlet to supply power to the scanner.
5. Power up the host system.
6. Attach the "MX" to the MS700i/MS720i scanner via the LSO cable that terminates to a 10-pin modular connector.

Note: When the MS700i/MS720i scanner first receives power, the LEDs will flash and then the scanner will beep once. After the scanner performs this startup sequence, the green LED will remain on for a specified time showing that the laser is on.

Refer to the *MS700i and MS720i Laser Bar Code Projection Scanner Installation and User's Guide* for information on how to operate the scanner.



To maintain compliance with applicable standards, all circuits connected to the unit must meet the requirements for SELV (Safety Extra Low Voltage) according to EN 60950.

The following statement is applicable if the scanner will receive power from a host device such as a computer system.

Caution: To maintain compliance with standards CSA C22.2 No. 950/UL 1950 and norm EN60950, the power source must meet applicable performance requirements for a limited power source.

CONFIGURATION OF THE MS700I/MS720I WITH "MX"

To perform matching procedure refer to page 18.

Once the transmitter is assigned an ID number, configure the S700i/MS720i to accept RF communication. **Although the changes made in this section effect the receiver, the MS6130 performs all scanning.**

1. Scan the following bar code to enter the receiver's program mode.
(The MS700i/MS720i will beep three times):

Enter/Exit Program Mode for the Receiver



2. Enable the RF interface by scanning the following bar codes in order:



3. Exit program mode by scanning the bar code in Step 1 again.
4. Proceed to the procedure on the next page.

CONFIGURATION OF THE MS700I/MS720I WITH “MX” TO THE HOST SYSTEM

To perform matching procedure refer to page 18.

Before the MS700i/MS720i scanner ships from the factory, the factory programs the scanner to a group of default settings noted in the ScanSelect™ Scanner Programming Guide. An asterisk marks each default setting. The asterisk appears before the brief definition located near the bar code. Once RF communication establishes, change the default settings of your scanner to meet your individual scanning needs or your host system's communication requirements. Modify the scanner's settings by entering the program mode and scanning the appropriate bar codes that appear in the ScanSelect Scanner Programming Guide.

Note: When the **Load Defaults** bar code in the ScanSelect Scanner Programming Guide is chosen, it will automatically disable the RF low speed option. For the MS6130 to communicate to the MS700i/MS720i scanner, re-enable the RF Low Speed Option (refer to the procedure above).

CONFIGURATION OF THE "MX" TO THE SCANPAL® DATA COLLECTOR

To perform matching procedure refer to page 18.

The RS-232 parameters marked with an asterisk (*) in the charts are the default settings of the "MX". The charts are in the *Default Settings of the MS6130 and "MX" Receiver* section of this guide. To communicate with each other properly, the "MX" and ScanPal must have matching RS-232 parameters. However, the **Enter/Exit Program Mode** bar code in the MS4120 Programming Guide will not cause your "MX" to enter or exit program mode. Scan the **Enter/Exit Program Mode for the Receiver** bar code in the following procedure.

Before completing RF communication, program the ScanPal to the same settings as the IBM® PC XT, AT or PS/2 compatible computer. Once completed and the receiver and MS6130 have the same assigned ID number, configure the "MX" to the same settings as ScanPal.

1. Program the ScanPal to the same settings as the PC.
(Refer to the *Programming the ScanPal* section in the ScanPal® Data Collector Installation and User's Guide)
2. Scan the following bar code to enter program mode.
(The "MX" receiver will beep three times):



3. Scan the appropriate communication options in the MS4120 Programming Guide.
4. Exit program mode by scanning the bar code in Step 1 again.

Note: Scan the **Enter/Exit Program Mode for the Receiver** bar code and exit program mode if the PC uses the same parameters as the default settings of ScanPal.



CONFIGURATION OF THE "MX" TO THE RS-232, LIGHT PEN OR KEYBOARD WEDGE HOST SYSTEM

To perform matching procedure refer to page 18.

The light pen, RS-232 and Keyboard Wedge parameters marked with an asterisk (*) in the charts are the default settings of the "MX". The charts are in the *Default Settings of the Transmitter and "MX" Receiver* section of this guide. To communicate with a host system properly, program the "MX" to match the host system's requirements. However, the **Enter/Exit Program Mode** bar code in the MS4120 Programming Guide will not cause your "MX" to enter or exit program mode. Scan the **Enter/Exit Program Mode** for the Receiver bar code in the following procedure. Once the MS6130 is assigned an ID number, configure the "MX" to the correct communication protocol.

1. Scan the following bar code to enter program mode.
(The "MX" receiver will beep three times):



2. Scan the following bar code to confirm the receiver is using the original factory settings.



3. Scan the appropriate communication options in the MS4120 and MS951 Programming Guides.
4. Exit program mode by scanning the following bar code.
(The "MX" receiver will beep three times):



KEYBOARD WEDGE (KB) INTERFACE

Scan the ENABLE KB WEDGE INTERFACE bar code if your communication requirement is keyboard emulation. The scanner will provide keyboard emulation by converting the scanned bar code data to the PC keyboard scan code equivalent.

Enable Keyboard Wedge Interface



KB Parameter - Keyboard Type

The following bar codes are used to define the type of keyboard in use. If necessary, scan the appropriate bar code.

** AT Keyboard (includes IBM® PS/2: Models 50, 55, 60, 80)



XT Keyboard



Enable IBM PS/2 Keyboard (Models 30, 70, 8556)



** Disable IBM PS/2 Keyboard (Models 30, 70, 8556)



Enable Single-Ended Keyboard Emulation



KEYBOARD WEDGE (KB) INTERFACE (CONTINUED)

KB Parameter – Keyboard Type

The following bar codes are used to define the keyboard country type. If necessary, scan the appropriate bar code.

** USA Keyboard



UK Keyboard



France Keyboard



Germany Keyboard



Italy Keyboard



Spain Keyboard



Belgium Keyboard



IBM KB4700 Financial Keyboard



Swiss Keyboard



Reserved



KEYBOARD WEDGE (KB) INTERFACE (CONTINUED)



KB Parameter - Caps Lock Mode

When Caps Lock is used on the keyboard, choose ENABLE CAPS LOCK. Once enabled, the scanner will simulate Caps Lock keyboard input. This mode will not work with all keyboard types.



To detect automatically if Caps Lock is used, enable AUTO-DETECTION CAPS LOCK MODE. This will only work with an AT computer.

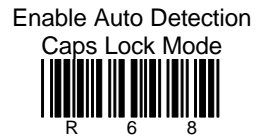

KEYBOARD WEDGE (KB) INTERFACE (CONTINUED)

KB Parameter - Alt Mode

When this option is enabled, the scanner will duplicate this keyboard sequence: Hold down the Alt key; type the decimal number that corresponds to the appropriate keyboard character. Caution should be observed when using Alt mode because a scanner to host application conflict may occur if the host software application uses the Alt key as a "Hot" key.

Enable Alt Mode



**Disable Alt Mode



KB Parameter - Inter Scan Code Delay (AT and PS/2 Modes)

The time specified with an interscan code delay bar code represents the amount of time between individual 9 bit scan codes. Each character of a bar code takes between two and twelve of these scan codes to be passed through to the PC via the keyboard interface. This parameter may need to be adjusted for operation with certain PC keyboard BIOS's. Network operating systems often use microprocessor time slices to service network information requests instead of the keyboard interface. While not an issue with manually entered keystrokes, this timing can be critical with automatic scanner data entry. Interscan code delays can be a useful system tuning tool in these environments.

** 800 Microsecond Delay



7.5 Millisecond Delay



15 Millisecond Delay



KB Parameter - XT - Clean-Up Bit

Some keyboard BIOS's require a "cleanup bit" to be transmitted before an actual scan code being clocked over to the motherboard. Enabling this feature will cause the scanner to send this extra bit to the host computer. More commonly found on older XT style BIOS's, and some AT BIOS's. (required by some NEC 80286 machines).

Enable Cleanup Bit



** Disable Cleanup Bit



CONFIGURATION OF THE MS6130 HAND-HELD

To perform matching procedure refer to page 18.

Before the MS6130 scanner ships from the factory, the factory programs the scanners to a set of default settings. These default settings can be found in the MS4120 Programming Guide. The default settings have an asterisk that appears before the brief definition located near the bar code. Once RF communication establishes, change the default settings of your scanner to meet your individual scanning needs. Configure the scanner by scanning the Transmitter Enter/Exit Program Mode bar code and the appropriate bar codes in the MS4120 Programming Guide.

For example, to program the MS6130 not to read ITF (Interleaved 2 of 5) bar code types:

- With the MS6130, scan the Enter/Exit Program Mode bar code in the MS4120 Programming Guide, the Disable ITF bar code, then the Enter/Exit Program Mode bar code again.

Note: When the MS6130 is in program mode, never scan any of the RS-232 or light pen options marked with an "R". The list of options is in the *Default Settings of the Transmitter and "MX" Receiver* section of this guide when using the MS4120 Programming Guide. The MS6130 is in program mode when scanning the Enter/Exit Program Mode bar code in the MS4120 Programming Guide.

ENABLING THE MS700i/MS720i SCANNER'S RF LOW SPEED OPTION

Before beginning this procedure, perform all steps in the sections, *Matching the Transmitter to the Receiver* and *Configuration of the MS700i/MS720i with "MX"*.

Use the MS700i/MS720i scanner to scan the following bar codes.

1. Temporarily cover the bar code below Step 3. Scan the following bar code to enter program mode.
(The MS700i scanner will beep three times):

Enter/Exit Program Mode for the Receiver



2. Temporarily cover the bar code in Step 1. Scan the **Enable RF Low Speed Option** bar code below Step 3.
3. Exit program mode by scanning the bar code in Step 1 again.

Enable RF Low Speed Option



CHANGING THE ID

In order for the MS6130 to send data to the correct receiver, they must have a matching ID number. The ID number is the serial number of the receiver. When the matching procedure is completed, the receiver will accept data only from a MS6130 that has the matching ID number. Each receiver is programmed with its serial number before it leaves the factory.

1. To program a new ID for the receiver, HANDSET (Version 1.14 or greater) must be used. Type the following at the DOS prompt:

HANDSET /X

2. Power up the receiver, but DO NOT scan any bar codes.
3. Select "Enter Program Mode". Select the appropriate SERIAL PORT (COM 1 or COM 2) on the PC. Make sure the Receiver is connected to the SERIAL PORT selected.
4. Select "Get Scanners Settings". A screen will appear showing all of the options available.
5. Using the arrow keys, move down to the section labeled "Metro ID#". Locate the serial number on the case of the receiver. Enter this 10-digit number into the "Metro ID#" section.
6. Press the "F5" key to program the receiver.
7. The receiver will beep when programming is completed. The receiver is now programmed with its proper ID. Exit HANDSET by pressing "F9" and then press "7".
8. Power Down the receiver.

MATCHING PROCEDURE

With the MS6130, scan the following bar codes starting from the top down:

Transmitter Enter/Exit Program Mode



Recall Defaults



Enable RF Communications



Transmitter Enter/Exit Program Mode



Locate the model label on the case of the receiver. Scan the serial number bar code.

The receiver and MS6130 are now matched.

For information on how to configure the receiver, refer to the appropriate section in this guide.

Note: If using more than one MS6130 with one receiver, perform the above procedure for each MS6130. Since each MS6130 has the same ID number, the receiver will accept data from all of the scanners

PARTS OF THE MS6130 HAND-HELD BAR CODE SCANNER

Becoming familiar with the features of the MS6130 hand-held scanner will help when operating one of these scanners. The illustration and list explain the pertinent parts.

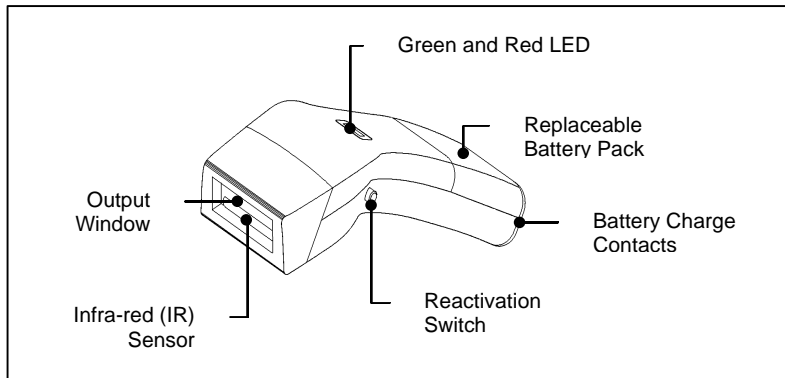

Figure 4: Scanner Parts

- | | |
|--------------------------------|--|
| Battery Charge Contacts | Receptacle for the battery charger. |
| Reactivation Switch | Turns the unit on after a timeout. Press the button from the bottom. |
| Green and Red LEDs | When the red LED is on, the laser is on. If the green LED flashes on, the scanner has read a bar code successfully. Communication to the host is complete when the receiver beeps. |
| Infrared Object Sensor | When a specified time has elapsed without any scanning, the unit will enter a "standby" mode. To reactivate the unit, remove the current object and present an object in front of the output window again. |
| Output Window | This aperture emits laser light. |

COMPONENTS OF THE MS6130 SERIES STAND

The following are the components used to build the MS6130 series stand (MLPN: 45880).

1. Cradle
2. Stand Charger Pack
3. Pole Cover
4. Flex pole
5. Stand Base Cover
6. Stand Base
7. Charger Transformer
8. Charger Pack Screws
9. Mounting Screws
10. Lock Washer

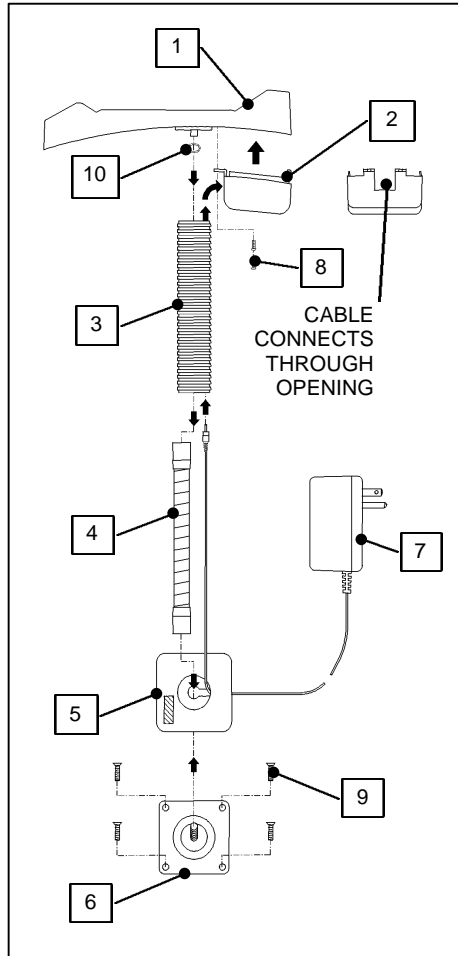

Figure 5: Scanner Parts

INSTALLATION OF THE MS6130 SERIES STAND

Refer to for numbered components on the previous page

1. Use the stand base (6) as a template to drill and mount the base to the counter using the mounting screws (9) provided.
2. Feed the wire from the transformer (7) through the slot in the base cover (5) approximately 9" of the wire.
3. Press the base cover (5) over the base (6).
4. Attach the flex pole (4) to the base (6).
5. Slide the flex cover (3) over the pole (4) and wire.
6. Attach the cradle (1) to the flex pole (4) using the lock washer (10) to connect the transformer.
7. Insert the transformer plug into the connector inside the stand charger pack (2).
8. Clip the charger pack to the bottom of the cradle (1) lock in place using two screws (8).

Stand LED Indicators (with the scanner in the stand)

No LED indicates trickle charge and the green LED indicates fast charge. To change from trickle charge to fast charge, simply lift the scanner from the stand and replace.

Note: When both scanner LEDs blink, it is an indication of a low battery.

INSTALLATION OF THE 6000 SERIES UNIVERSAL CHARGING STAND

MLPN: 45558 - 115V, 45559 - 230V and 45560 - 240V (UK)

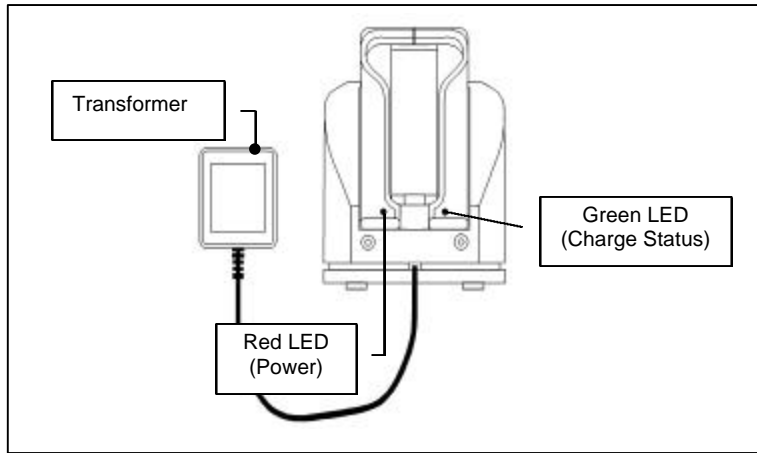

Figure 6: Universal Charging Stand

PERMANENT COUNTER TOP INSTALLATION

1. Separate weighted base from rotating base by removing the (4) four screws.
2. Use the rotating base as a drill template.
3. Use the (4) four wood screws provided to mount the base to the counter top securely.
4. Snap the cup assembly to the base.

Note: For non-permanent installation, snap the cup assembly onto the weighted base

CHARGE STATE	CHARGE LED STATUS
Battery Absent	LED off
Charge Pending	LED on for 0.125sec, off for 1.375sec
Fast-Charge	LED on
Charge Complete and Top-Off	LED on for 0.125 sec, off for 0.125sec

NiCd BATTERY CHARGER WITH RECONDITIONING FEATURE

MLPN: 45561 - 115V and 45562 - 230V

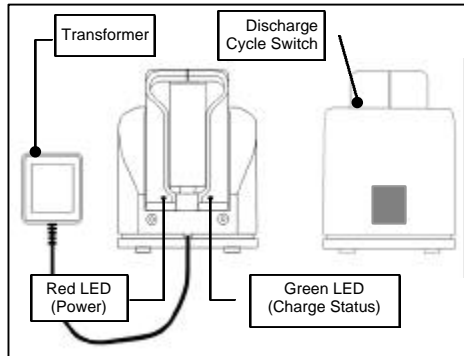

Figure 6: Reconditioning

How to Recondition

1. Place the scanner into the charge stand.
2. Push the stand tilt cup in the extreme down position to expose the hole for the discharge cycle switch.
3. Use a pin to push the discharge cycle switch located beneath the hole.
4. When the discharge mode is initiated the green LED flashes.

RECOMMENDED USE

To maintain charge capacity, the NiCd batteries must be discharged fully before charging. We call this process reconditioning.

Recondition if:

- The batteries were not used within 20 days
- The batteries were not discharged (approximately two hours of continuous operation) at least once a week
- Low battery indicators:
 - Both LED's on the scanner blink
 - The scanner quietly beeps twice while scanning

Recondition once a week if:

- The batteries do not get discharged for more than 20% (approximately ½ hour) of their capacity before recharging.

Recondition once every two weeks if:

- The batteries do not get discharged for more than 50% (approximately 1 hour) of their capacity before recharging.

Note: The day to day usage of the NiCd batteries will determine the frequency of the discharges (reconditioning).

Charge State	CHG LED Status
Battery Absent	LED off
Charge Pending	LED on for 0.125sec, off for 1.375sec
Discharge-Before-Charge	LED on for 1.375sec, off for 0.125sec
Fast-Charge	LED on
Charge Complete Top-Off	LED on for 0.125 sec, off for 0.125sec

VISUAL INDICATORS

The scanner has red and green LEDs. When the scanner is on, the LEDs indicate the status of the scan and scanner.

No Red or Green



The scanner will turn off if the scanner has been dormant for a specified time. To reactivate the unit, direct the output window up then down toward the bar coded product. If the unit has been dormant for longer than 10 minutes, reactivating the unit by pressing the button on the side of the MS6130 will be necessary.

Red Flash; Green Flash;



When the scanner *first* receives power, the steady red LED will flash, followed by the green LED.

Steady Red



When the laser is on, the red LED will also be on. This occurs when an object is in the scan field. If the scanner does not detect a bar code within approximately 2.5 seconds, the red LED will shut off indicating that the laser is no longer on. If the red LED remains on for longer than 7.5 seconds, then the scanner is in program mode.

Steady Red; Green Flash

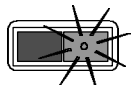

When the scanner *successfully* reads a bar code, the green LED will flash. If the green LED does not flash, then the bar code read was *not* successful.

Repetitive Red Flashes

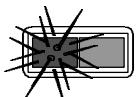

When the red LED flashes several times while it lays upon a stationary surface, then an object is within the scan field and is activating the IR sensor. This can occur even while the scanner is lying upon the counter or cradle. To eliminate this disturbance, direct the scan window toward a different location.

AUDIBLE INDICATORS

When the scanner and “MX” receiver are in operation, they provide audible indications. These sounds indicate the status of the scan and scanner.

One Beep

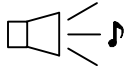

When the “MX” Receiver *first* receives power, the unit will beep once.

If the scanner *successfully* reads a bar code, the green light will flash. If the “MX” receiver successfully receives the data from the MS6130, the “MX” will beep once.

Razzberry Tone

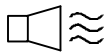

If, upon power up, the scanner emits a razzberry tone, then the scanner has failed diagnostics.

The “MX” receiver will emit a razzberry tone if an invalid bar code is scanned while the receiver is in program mode.

The “MX” receiver can be programmed to emit a razzberry tone when the timeout occurs during communication between the host and receiver.

Refer to the MS4120 Programming Guide section, *Audible Indicators for Communication Timeouts* to program this feature.

Two Beeps

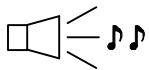

The MS6130 scanner will quietly beep twice when scanning a bar code if the batteries become low.

Three Beeps

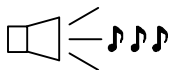

When scanning the MS6130 Enter/Exit Program Mode bar code in the MS4120 Programming Guide, the green LED will flash three times while the scanner simultaneously beeps three times. When exiting the program mode, the same visual and audible indications will occur. After this sequence is completed, the red LED will turn off. When scanning the Enter/Exit Program Mode for the Receiver bar code, the “MX” receiver will beep three times to indicate it is in or exiting out of the program mode.

(continued next page)

AUDIBLE INDICATORS (CONTINUED)

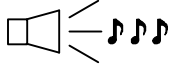

The “MX” receiver can be programmed to emit three beeps when the timeout occurs during communication between the host and receiver. Refer to the MS4120 Programming Guide section, *Audible Indicators for Communication Timeouts* to program this feature.

There are four settings available for the tone of the beep for the receiver. Refer to the MS4120 Programming Guide section, *Beeper Tones* to program the feature to change the tone or turn the beeper off.

LABELS

The MS6130 scanner is either a CDRH Class II laser system or an IEC Class 1 Laser System. Your unit will have a CDRH Class II caution label or LASERKLASSE 1 label affixed below the model number label. The model number/avoid exposure label is located on the bottom of the scanner's head. The following are examples of these labels:

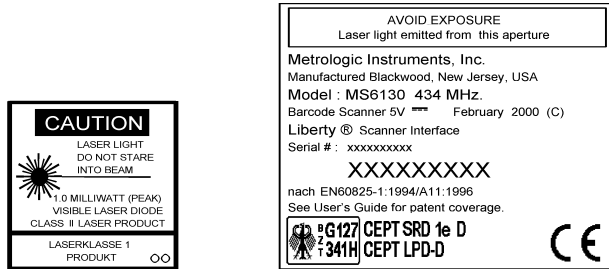

MAINTENANCE

Smudges and dirt can interfere with the proper scanning of a bar code. Therefore, the output window will need occasional cleaning.

1. Spray glass cleaner onto lint free, non-abrasive cleaning cloth.
2. Gently wipe the output window.

TROUBLESHOOTING

1. The receiver can receive data from a MS6130 with its own ID or 10 zeroes. It's own ID can be received all the time. When using 10 zeroes, the first scan the receiver gets must have 10 zeroes as its ID and from that point on the receiver will accept both ID's.

Power down the receiver. Using the MS6130, scan the bar codes from section 9 in the Matching MS6130 to the Receiver section and use the following bar code as the ID number.



Note: Use this bar code for troubleshooting purposes only.

2. Power up the receiver.
3. If the user is trying to match a new ID to the receiver and the receiver is powered up, the receiver will beep 3 times if the ID number it receives matches its current ID.
4. When the MS6130 is in program mode, never scan any of the RS-232 or light pen options marked with an "R". The list of options is in the *Default Settings of the MS6130 and "MX" Receiver* section of this guide when using the MS4120 Programming Guide. The MS6130 is in program mode when scanning the **Enter/Exit Program Mode** bar code in the MS4120 Programming Guide. If a receiver option is chosen while the MS6130 is in program mode, RF communication between the MS6130 and receiver may terminate. If this occurs, the only way to reestablish RF communication is by performing all the RF configuration procedures again.

APPENDIX A

Specifications

RF Link Characteristics

Frequencies:	One of the following depending on the country of operation: 418MHz 434MHz 912MHz
Bandwidth:	220kHz
Modulation:	FM
Certification:	No FCC licensing required
RF Protocol:	One way data transmission Transmission time at a maximum of 100 ms 50K baud data rate Dedicated transmitter(s) to receiver link
Operating Range:	Up to 30 feet (conditions permitting)

Specifications subject to change without notice

MS6130 Bar Code Scanner Specifications

UL Listed:	US and Canada
FCC ID:	LW5613 (912MHz only)
RF Output Power:	20 uW max. (912MHz only)
Current:	Supplied by rechargeable/replaceable batteries
Antenna:	Integral
Dimensions:	205mmL x 63mmW x 24mmH
Weight:	10.5 Oz
Maximum Radiant Power:	0.9mW Peak
VLD Wavelength:	675nm \pm 5nm

APPENDIX A (CONTINUED)

MX003 Series Scanner Interface Specifications

FCC ID: LW5003
Operating Voltage: 5Vdc
Antenna: Integral
Dimensions: 3.54" x 1.97" x 0.94"
Weight: 0.175 lb.
UL Listed: US and Canada

Model Number	Operating Frequency	Data Interface RS-232 Light Pen	Data Interface Keyboard Wedge
MX003	912 MHZ	✓	
MX003-17	912 MHZ		✓
MX0033	418 MHZ	✓	
MX0033-17	418 MHZ		✓
MX0034	434 MHZ	✓	
MX0034-17	434 MHZ		✓

Model designation may include the suffix "J" used to indicate the addition of an audio signal output jack.

APPENDIX A (CONTINUED)

Specifications of Battery Pack

Battery Type:	"AA" NiCd Rechargeable
Configuration:	3 Batteries/Pack
Nominal Voltage:	3.6 VDC
Maximum Voltage:	4.8 VDC
Capacity:	600 mA
Charge Cycles:	Over 500 Full Charge/Discharge
Charge Time:	4 Hours
Short Circuit Protection:	Auto/Reset Fuse 1.7A Hold Current

Temperature Characteristics (Degrees Celsius) of each Cell:

Charge:	0 to +45
Discharge:	-20 to +60
Storage (Long):	-30 to +35

UK Compliance

To charge the batteries in the MS6130 - 418MHz, remove the ESD cover from the bottom of the unit. Refer to the battery charge rate for additional information. After a full charge, replace the cover over the battery contacts. The cover should remain in place during operation

Default Settings of the MS6130 and “MX” Receiver

Before the MS6130 hand-held scanner and “MX” Receiver ships from the factory, the factory programs the scanners to a group of default settings. An asterisk (*) in the charts on the following pages marks the default settings of the units. If an asterisk is not in the default column then the default setting is Off or Disabled.

The MS6130 and “MX” receiver do not support every parameter. For those parameters that are a transmitter function, a letter “T” will appear in the second column of the charts, for the “MX”, the letter “R”.

RS-232, light pen and keyboard wedge emulation does not support every parameter. If your host device’s communication supports a parameter listed in the charts on the following pages, a check mark will appear.

In order for the “MX” receiver to communicate with your RS-232, light pen or keyboard wedge host device properly, program it to meet your individual scanning needs. Since each host system is unique, change the default settings to match your host system requirements. To modify default settings, refer to the MS4120 and MS951 Programming Guides.

Note: If your “MX” Interface is connected to a MS700i/MS720i scanner, use the bar codes in the ScanSelect Programming Guide to match your scanner’s settings to the host system requirements.

T - Transmitter (MS6130 Hand-held)
R - Receiver (“MX”)

Parameter	T - Transmitter R - Receiver	Default	RS-232	Light Pen
Enter/Exit Program Mode	T			
Recall Defaults	R			
Enter Program Mode After Any Scan	T	*	✓	✓
Enter Program Mode Only on First Scan	T		✓	✓
Short Range Activation Out of the Stand	T		✓	✓
Long Range Activation Out of the Stand	T	*	✓	✓
Short Range Activation in the Stand	T		✓	✓

APPENDIX B (CONTINUED)

Parameter	T - Transmitter R - Receiver	Default	RS-232	Light Pen
Long Range Activation in the Stand	T	*	✓	✓
Normal Scan	T	*	✓	✓
Pulsing Scan	T		✓	✓
Custom Scan	T		✓	✓
Green LED Rescan Indicator	T		✓	✓
Short Same Symbol Rescan	T		✓	✓
Long Same Symbol Rescan	T	*	✓	✓
Alternate Beeper Tone 1	R		✓	✓
Alternate Beeper Tone 2	R	*	✓	✓
Alternate Beeper Tone 3	R		✓	✓
No Beeper Tone	R		✓	✓
Two Second Time-out	R		✓	
No Two Second Timeout	R	*	✓	
Razzberry Tone on Timeout	R		✓	
No Tone on Timeout	R	*	✓	
Three Beeps on Timeout	R		✓	
Beep Before Transmit	R	*	✓	
Beep After Transmit	R		✓	
Baud Rate	R	9600	✓	
Parity	R	Space	✓	
8 Data Bits	R		✓	
7 Data Bits	R	*	✓	
RTS/CTS	R		✓	
Character RTS/CTS	R	*	✓	
Message RTS/CTS	R		✓	
ACK/NAK	R		✓	
XON/XOFF	R		✓	
No Intercharacter Delay	R	*	✓	
1 Millisecond Intercharacter Delay	R		✓	
5 Millisecond Intercharacter Delay	R		✓	
25 Millisecond Intercharacter Delay	R		✓	

APPENDIX B (CONTINUED)

Parameter	T - Transmitter R - Receiver	Default	RS-232	Light Pen
DTR Input	R		✓	
Carriage Return	R	*	✓	
Line Feed	R	*	✓	
ETX Suffix	R		✓	
Tab Prefix	R		✓	
Tab Suffix	R		✓	
Prefix ID for UPC/EAN	R		✓	
Suffix ID for UPC/EAN	R		✓	
Bars High	R	*		✓
Spaces High	R			✓
Transmit as Scanned	R	*		✓
Transmit as Code 39	R			✓
Poll Light Pen 5 Volts	R			✓
No Poll Light Pen	R	*		✓
UPC	T	*	✓	✓
EAN	T	*	✓	✓
Code 39	T	*	✓	✓
Codabar	T	*	✓	✓
Code 128	T	*	✓	✓
Code 93	T	*	✓	✓
Interleaved 2 of 5 (ITF)	T	*	✓	✓
MSI Plessey Decode	T		✓	✓
Enable Code 11 Decode	T		✓	✓
Enable Airline 2 of 5	T		✓	✓
Full ASCII Code 39	T		✓	✓
Italian Pharmaceutical	R		✓	✓
Minimum 1 Character Code Length	T		✓	✓
Minimum 3 Character Code Length	T	*	✓	✓
Minimum 6 Character Code Length	T		✓	✓

APPENDIX B (CONTINUED)

PARAMETER	T - TRANSMITTER R - RECEIVER	DEFAULT	KEYBOARD WEDGE
Keyboard Type	R		✓
AT	R	*	✓
XT	R		✓
PS2	R		✓
Keyboard Country Type	R		✓
USA	R	*	✓
UK	R		✓
France	R		✓
Germany	R		✓
Italy	R		✓
Spain	R		✓
Belgium	R		✓
KB4700	R		✓
Swiss	R		✓
Caps Lock	R		✓
Autodetection	R		✓
User Defined	R		✓
Transmit Cleanup Bit	R		✓
Transmit Alt Mode	R		✓
Transmit 0F0H Break Character	R	*	✓
Inter Scan Code Delay	R		✓
0	R		✓
800 msec	R	*	✓
7.5 msec	R		✓
15 msec	R		✓
Intercharacter Delay	R		✓
0	R		✓
1 msec	R		✓
10 msec	R	*	✓
100 msec	R	*	✓
Stand Alone Scanner Mode	R		✓

MX003 Series Scanner Interface Pin Assignments

The interfaces are equipped with a shielded, 10-pin modular jack manufactured by Steward Stamping. The mating connector is a Steward Stamping shielded plug #937-SP-361010. Caution should be used when working with cables for this port because there is typically power present for scanner interface operation.

Models MX003, MX0033 and MX0034:

Pin	Function
1	Power (d/c)/Shield Ground
2	RS-232 Transmit Output
3	RS-232 Receiver Input
4	RTS Output
5	CTS Input
6	DTR Input
7	LP/DATA
8	NC
9	+5Vdc Power to Scanner Interface
10	NC

Models MX003-17, MX0033-17 and MX0034-17:

Pin	Function
1	Power (d/c)/Shield Ground
2	RS-232 Transmit Output
3	RS-232 Receiver Input
4	Keyboard Data
5	Keyboard Clock
6	PC Clock
7	PC Data
8	NC
9	PC +5V/ External +5V
10	NC

APPENDIX D

Warranty and Disclaimer

Limited Warranty

The MS6130 scanners are manufactured by Metrologic at its Blackwood, New Jersey, U.S.A. facility. The MS6130 scanners have a two (2) year limited warranty from the date of manufacture. Metrologic warrants and represents that all MS6130 scanners are free of all defects in material, workmanship and design, and have been produced and labeled in compliance with all applicable U.S. Federal, state and local laws, regulations and ordinances pertaining to their production and labeling.

This warranty is limited to repair, replacement of Product or refund of Product price at the sole discretion of Metrologic. Faulty equipment must be returned to the Metrologic facility in Blackwood, New Jersey, U.S.A. or Puchheim, Germany. To do this, contact Metrologic's Customer Service/Repair Department to obtain a Returned Material Authorization (RMA) number.

In the event that it is determined the equipment failure is covered under this warranty, Metrologic shall, at its sole option, repair the Product or replace the Product with a functionally equivalent unit and return such repaired or replaced Product without charge for service or return freight, whether distributor, dealer/reseller, or retail consumer, or refund an amount equal to the original purchase price.

This limited warranty does not extend to any Product which, in the sole judgement of Metrologic, has been subjected to abuse, misuse, neglect, improper installation, or accident, nor any damage due to use or misuse produced from integration of the Product into any mechanical, electrical or computer system. The warranty is void if the case of Product is opened by anyone other than Metrologic's repair department or authorized repair centers.

THIS LIMITED WARRANTY, EXCEPT AS TO TITLE, IS IN LIEU OF ALL OTHER WARRANTIES OR GUARANTEES, EITHER EXPRESS OR IMPLIED, AND SPECIFICALLY EXCLUDES, WITHOUT LIMITATION, WARRANTIES OF MERCHANTABILITY AND FITNESS FOR A PARTICULAR PURPOSE UNDER THE UNIFORM COMMERCIAL CODE, OR ARISING OUT OF CUSTOM OR CONDUCT. THE RIGHTS AND REMEDIES PROVIDED HEREIN ARE EXCLUSIVE AND IN LIEU OF ANY OTHER RIGHTS OR REMEDIES. IN NO EVENT SHALL METROLOGIC BE LIABLE FOR ANY INDIRECT OR CONSEQUENTIAL DAMAGES, INCIDENTAL DAMAGES, DAMAGES TO PERSON OR PROPERTY, OR EFFECT ON BUSINESS OR PROPERTY, OR OTHER DAMAGES OR EXPENSES DUE DIRECTLY OR INDIRECTLY TO THE PRODUCT, EXCEPT AS STATED IN THIS WARRANTY. IN NO EVENT SHALL ANY LIABILITY OF METROLOGIC EXCEED THE ACTUAL AMOUNT PAID TO METROLOGIC FOR THE PRODUCT. METROLOGIC RESERVES THE RIGHT TO MAKE ANY CHANGES TO THE PRODUCT DESCRIBED HEREIN.

North America Headquarters

Metrologic Instruments, Inc. 90 Coles Road Blackwood, NJ 08012-4683	Customer Service: 1-800-ID-METRO Tel: 856-228-8100 Email: info@metrologic.com Website: www.metrologic.com
---	---

Germany

Metrologic Instruments GmbH Dornierstrasse 2 82178 Puchheim b. Munich, Germany	Tel: 49-89-89019-0 Fax: 49-89-89019-200 Email: info@europe.metrologic.com
---	---

Notices

Notice - *applicable to 912 MHZ devices only*

This device complies with part 15 of the FCC Rules. Operation is subject to the following two conditions: (1) This device may not cause harmful interference, and (2) this device must accept any interference received, including interference that may cause undesired operation. Any unauthorized changes or modifications to this equipment could void the users authority to operate this device.

Notice - *applicable to 912 MHZ devices when used in Canada*

Operation is subject to the following two conditions: (1) this device may not cause interference, and (2) this device must accept any interference, including interference that may cause undesired operation of the device.

Caution

Use of controls or adjustments or performance of procedures other than those specified herein may result in hazardous laser light. Under no circumstances should the customer attempt to service the laser scanner. Never attempt to look at the laser beam, even if the scanner appears to be nonfunctional. Never open the scanner in an attempt to look into the device. Doing so could result in hazardous laser light exposure. The use of optical instruments with the laser equipment will increase eye hazard.

Patents

“Patent Information

This METROLOGIC product may be covered by one or more of the following U.S. Patents:

U.S. Patent No. 4,930,848; 4,958,984; 5,081,342; 5,260,553; 5,340,971; 5,340,973; 5,424,525; 5,468,951; 5,484,992; 5,525,789; 5,528,024; 5,591,953; 5,616,908; 5,627,359; 5,661,292; 5,777,315; 5,789,730; 5,789,731; 5,808,285; 5,811,786; 5,825,012; 5,886,337; 5,925,870; 5,925,871; 5,929,419; 5,939,701; D315,901

4,360,798; 4,369,361; 4,387,297; 4,460,120; 4,496,831; 4,593,186; 4,607,156; 4,673,805; 4,736,095; 4,758,717; 4,816,660; 4,845,350; 4,896,026; 4,923,281; 4,933,538; 4,992,717; 5,015,833; 5,017,765; 5,059,779; 5,117,098; 5,124,539; 5,130,520; 5,132,525; 5,140,144; 5,149,950; 5,180,904; 5,200,599; 5,229,591; 5,247,162; 5,250,790; 5,250,791; 5,250,792; 5,262,628; 5,280,162; 5,280,164; 5,304,788; 5,321,246; 5,324,924; 5,340,971; 5,340,973; 5,396,053; 5,396,055; 5,408,081; 5,410,139; 5,436,440; 5,449,891 5,468,949; 5,479,000; 5,532,469; 5,545,889; 5,874,721

No license right or sublicense is granted, either expressly or by implication, estoppel, or otherwise, under any METROLOGIC or third party intellectual property rights (whether or not such third party rights are licensed to METROLOGIC), including any third party patent listed above, except for an implied license only for the normal intended use of the specific equipment, circuits, and devices represented by or contained in the METROLOGIC products that are physically transferred to the user, and only to the extent of METROLOGIC’s license rights and subject to any conditions, covenants and restrictions therein.”

Other worldwide patents pending.

INDEX

A

AC 4, 6
Adapter 3
Asia ii
Audible indicators 25, 26

B

Battery pack 31
Beep(s) 1, 2, 6, 7, 9, 10, 16
17, 19, 23, 25, 26, 28

C

Cable 3, 6
Changing ID 17
Clean 27
Clean-up bit 14
Compliance 4, 6, 31
Configuration(s) 7-10, 15, 16, 28
Connections 4, 6
Copyright ii
Current 29
Customer Service ii

D

Default settings 32-35
Dimensions 29
Disclaimer 37

E

Email ii
ESD 31
Europe ii
External power source 6

F

Fax ii
Function(s) 2

G

Germany (GmbH) ii
Green LED 6, 19, 21, 23-25

H

Headquarters ii
Host 4, 6, 8, 10, 14, 32

I

ID 7, 9, 10, 17, 18, 28
Indicators 21, 23-25
Installation
Stand 21, 22
Internet ii

K

Keyboard wedge 10-14, 29

L

Labels 27
LASERKLASSE 1 27
LEDs 1, 6, 19, 21-25
Liberty® interface 1-3, 7, 9, 10
, 16, 29
List 3
Locations ii
Low speed options 8, 16

M

Maintenance 27
Matching procedure 18
MCA95 13
Model number 27
MS6130 1-3, 7-10, 15, 17-21
24, 25, 27-29, 31, 32
MS700i/MS720i 1, 6-8, 32
"MX" 2-10, 15, 16, 25, 26, 28, 32

N

NiCd battery charger 23, 31
Notices 38

O

Output window 19, 24, 27

P

Parts 19
Patents 40
Programming guide 3, 8-10
15, 25, 26, 28, 32

INDEX (CONTINUED)

R

Receiver board	2
Red LED	1, 19, 24, 25
Rights property	40
RS-232	9, 10, 28

S

ScanPal®	2, 3, 9
ScanSelect	3, 8, 32
Shipping carton	3
South America	ii
Specifications	29-31
Stand	3, 20-23

T

Temperature	31
Tones	26
Transformer	4, 6, 20, 21
Transmitter	1-3, 7, 10, 15, 16, 18, 29, 32-35
Troubleshooting	28

U

Unpacking list	3
USA corporate headquarters	ii

V

Visual indicators	24
Voltage	4-6, 29, 31

W

Weight	29
Window	1, 19, 24, 27